



MAKSIWA®

BMT.3200.IR

Sliding Panel Saw Titanium

INSTRUCTION MANUAL



Attention: Read this manual before using the machine.

Greetings,

Congratulations, you just purchased the BMT.3200.IR Titanium Precision Saw, which was developed with the Maksiwa's highest standards of technology and quality. Your BMT.3200.IR Titanium Precision Saw allows you to have the highest productivity in woodworking. Besides a great finish, the BMT.3200.IR ensures that your cuts are always precise. It should be noted that to use this machine with maximum efficiency, you should read and understand the instructions in this manual. Visit our website to know about our launches and other product lines:

www.maksiwa.com

Index

1	Safety Regulations.....	05
1.1	Workspace.....	05
1.2	Electrical Safety.....	05
1.3	Personal Safety.....	06
1.4	Machine Safety.....	06
2	Description.....	09
2.1	Specifications.....	09
2.2	Components.....	10
2.2.1	Mobile Arm.....	11
2.2.2	Mobile Table Guide.....	11
2.2.3	Blade Tilt Control Handle.....	12
2.2.4	Control Panel.....	13
2.2.5	Emergency Buttons/Switches.....	14
2.2.6	Main Table Lock.....	15
2.2.7	Sliding Table Handle.....	15
2.2.8	Adjustable Table Handle.....	16
2.2.9	Rear Extension Table.....	16
2.2.10	Rip Fence.....	17
2.2.11	Panel Pushing Handle.....	18
2.2.12	Blade Protector Cover.....	18
2.2.13	Dust Collection Port.....	19
2.2.14	Support Table.....	20
2.2.15	Wood Panel Clamp.....	20
2.2.16	Aluminum Table Guide.....	21
2.2.17	Scoring Blade Adjustment Location.....	22
2.2.18	Wood Panel Stopper.....	23
2.2.19	Main Blade Height Adjustment Handle.....	24
2.2.20	Aluminum Guide Extensions.....	24
2.2.21	Digital Readout.....	25
3	Installation.....	49
3.1	Electrical Installation.....	49
3.2	Assembly.....	51
4	Operation.....	65
4.1	Main Blade Adjustments.....	66
4.2	Scoring Blade Adjustments.....	67
4.3	How to Cut at Different Angles.....	68
4.4	How to Setup for Recurrent Cuts.....	69

4.5 Running a Piece.....	70
4.6 Cross Cutting.....	71
4.7 Cutting Frames, Boxes and Other Four-Sided Pieces.....	72
4.8 Bevel Cuts.....	72
4.9 Support for Long Parts.....	72
4.10 How to Adjust the Rip Fence.....	72
4.11 Main Blade.....	73
4.12 Fence Scale Alignment.....	74
4.13 Riving Knife Adjustment.....	74
4.14 Changing Scoring Blade.....	75
4.15 Rip Cutting.....	75
4.16 Lubrication.....	76
4.17 Replace Belts.....	77
5 Maintenance.....	78
5.1 General Cleanliness.....	78
5.2 Electrical Maintenance.....	78
5.3 Mechanical Maintenance.....	78
5.4 Saw Blade Lubrication Chart.....	79
5.5 Part Replacement and Disposal.....	79
6 Troubleshooting Guide.....	80
7 Exploded View.....	81
8 Terms of Warranty.....	124

1 Safety Regulations

Read all instructions in this manual. Failure to follow all instructions listed below may result in personal injury and equipment damage. **WARNING:** When using electrical equipment, always follow the safety precautions to reduce risk of fire, electric shock and personal injury. The manufacturer declares that they are not liable for damages to person(s) or object(s) which may be caused by failure to comply with the safety regulations.

1.1 Workspace

- Keep the work surface clean. Disorganized surfaces and areas are an invitation, for accidents in the work place.
- Do not use the saw in hazardous environments. Do not use the machine in places that are damp, wet, exposed to rain, or in the presence of flammable liquids or gases. Keep your work area well lit.
- Visitors must be kept at a safe distance from the workspace. Take the appropriate precaution by using padlocks or following the appropriate lock-out-tag procedures.

1.2 Electrical Safety

- Ensure that your power supply is in accordance with the rating of the machine. A 10% increase or decrease in voltage will cause power loss and overheating. All Maksiwa equipment is factory tested. If this Machine does not operate properly, first check the power supply.
- The BMT.3200.IR is constructed with two separate layers of electrical insulation. You do not have to ground the machine if the power supply comes built with an ground.
- **NOTE:** Double insulation is not a substitute for normal safety precautions when operating this machine. The insulation system is to add protection against personal accidents resulting from a possible failure of the machines electrical insulation.
- **CAUTION:** WHEN SERVICING OR REPAIRING THE MACHINE, ONLY USE OEM PARTS.
- The plug used for the machine must be rated for the correct voltage/Amps and compatible with the electrical outlet. Never modify the plug.
- Do not use any adapter plugs. Using the correct plug (without modifications) with the correct outlet will reduce the risk of electrical shock.

1.3 Personal Safety

- Stay alert, pay attention at what you are doing and use common sense when operating the machine. Do not use the machine when you are tired or under the influence of drugs, alcohol, or medication. If distracted, while operating the machine, it may in result in serious personal injury.



ALWAYS USE PROPER PROTECTION WHEN OPERATING THIS EQUIPMENT.

- Always wear safety glasses, face protection, safety anti-slip shoes, and ear protection to reduce personal injury.
- Do not wear loose clothing, gloves, chains, rings, bracelets or other accessories. It is also recommended to use hair protection.
- Do not over stretch to reach. Keep balanced and feet firmly planted at all times.
- Disconnect the machine from the power supply before servicing or performing repairs.
- Reduce the risk of unintended starts by making sure that the main power switch is turned off before plugging the cord into the outlet.
- Use recommended accessories. Refer to the instruction manual to check the recommended accessories. Improper use of the accessories may cause personal injury.
- Never stand on the machine. serious accidents can occur if the machine is tilted or if the blade is accidentally touched.

1.4 Machine Safety

- Turn off the saw, unplug the power cord, and wait until the blade stops, before performing any maintenance or adjustments to the machine.
- Make sure the blades are not worn, as for this will prevent the machine from cutting properly and overload the motors. Do not overload the Machine, it will perform the job better and safer if used as indicated. Do not force the machine by performing a job for which it was not intended for.
- Firmly secure your workpiece. Use clamps if necessary when you cannot secure the workpiece on to the table and against the guide by hand, or when your hand is dangerously close to the blade.
- Inspect the machine. Keep the blades sharp and clean for optimal performance. Follow the instructions on lubricating and changing accessories. Check the alignment of moving parts and for any damaged parts, before continuing to use the machine. A part that is damaged should be carefully examined to determine, if it is functioning properly and if it will affect the machines

performance. A blade cover or any other part that is damaged must be repaired or replaced immediately. Do not use the machine if any the switches do not work properly.

- Never leave the machine running unattended. Turn off the main power switch when not in use to prevent any accidents.
- Protect the power supply circuit with at least a fuse or circuit breaker. Do not attempt to operate the saw at any voltage other than the designated voltage.
- Make sure all blade washers and fasteners are clean. Tighten the shaft nut securely. Keep the saw blades sharp, make sure that the blades are facing the correct directions (main blade spins clockwise) (Scoring blade spins counter-clockwise). See fig 13-4 on pg. 39.
- Keep motor vents free of splinters or saw dust.
- Always use the blade guard cover.
- Keep your hands out of the way of the blades.
- Support long pieces with a wood fastening device.
- Do not use blades larger or smaller than recommended.
- Be careful not bend or damage the cooling fan on the rear of the motors.
- Do not force a cut, partial or complete, motor will shut down and can cause serious damage. Allow the motor to reach its top speed before starting the cut.
- Do not cut ferrous metals (those containing iron or steel in their composition) or any other masonry material.
- Do not use abrasives. Excessive heat generated by abrasive particles will damage the saw blades.
- Do not use blades designated for less than recommend amount.
- Do not cut small pieces without the aid of a fastener. Keep hands away from blades.
- Do not perform any hands-free operation.
- Do not reach around or behind the blades.
- Do not put your hands within 6 inches of the saw blades.
- Do not place your hands under the saw unless it is off and unplugged. The saw blades are exposed in the lower portion of the saw.
- Do not move the workpiece or lift the cover until the blade has stopped.
- Do not use the saw without the support base or if the support base is not properly secured.
- Do not use lubricants or cleaning products (particularly sprays and aerosols) in the vicinity of the plastic protector. The polycarbonate material used on the cover is sensitive to certain products chemicals.
- To Avoid KICKBACK (“Kickback” - the natural tendency of the workpiece to be thrown back towards the operator) keep the blade sharp, free of rust and dry resin; keep the cutting guide parallel to the saw blade; use the saw guards for all work where possible; push the workpiece completely through the saw blade before releasing it; Do not make longitudinal cuts on a workpiece that is twisted, deformed, or that does not have a straight end that serves as a guide; use an anti-kickback device when possible; never cut workpieces that cannot be fixed; Use the

guide when making a cross-section cut; and never cut a large workpiece with loose knots or other defects.

- **ATTENTION:** Any powder created by sanding, cutting, grinding, drilling, and other activities contains chemicals that can cause cancer, birth and other reproductive harm. Some examples of these products are: in lead; crystal silica brick, cement and other masonry products; and arsenic and chromium from chemically treated wood.
- **CAUTION:** Do not connect the machine to the power outlet until this manual is read and understood.
- Always tighten the adjusting tabs before using the saw. Keep hands 15 cm (6 in) away from the saw blade. Never perform operations hands-free and never cross your arms in front of the saw blade. Think, “ How can I avoid accidents?”.
- Do not operate the saw without the guards being in place. Never put your hands on the saw blade. Always wear safety goggles. Turn off the power and wait for the blade to stop before starting to service or making adjustments.

2 Description

The BMT.3200.IR Titanium precision saw is designed to provide excellent finishing cuts of MDF sheets. It has a slope of axis from 0° to 45° with digital display. Reinforced structure the BMT.3200.IR Titanium supports panels with a thickness of 25 mm (1 in). It also has a scoring blade to provide quality cuts. It has Independent motors, where the main saw motor has 5.0 HP for long periods of heavy work. With precision aluminum guides, the BMT.3200.IR Titanium is the right choice for anyone looking for quality and accuracy in their cuts.

2.1 Specifications

General:

- Weight: 1,519 LBS
- Machine dimensions (closed): L 132" X W 135" X H 65"
- Machine dimensions (max): L 192" X W 280" X H 65"
- Mobile table dimension: 14 1/8 X 132"
- Mobile table max travel length: 286"
- Fixed table max width: 59"
- Guide size (closed): 77"
- Guide size (max): 143"
- Slope inclination: 0° to 45°

Dust collection:

- Port 1 diameter: 4"
- Port 2 diameter: 4"
- Minimum CFM needed: 1000 CFM

Blade:

- Main blade diameter: 12"
- Main blade arbor size: 1 3/16" (30 mm)
- Scoring blade diameter: 4 3/4"
- Scoring blade arbor size: 3/4" (20 mm)
- Max tilt: 45°
- Max depth cut: 3 15/16"
- Max cutting length: 120"

NOTE: Pictures and illustrations in this manual are ILLUSTRATIVE only and may not be the actual color, contain the same labels or accessories, and are intended only to illustrate the technical part.

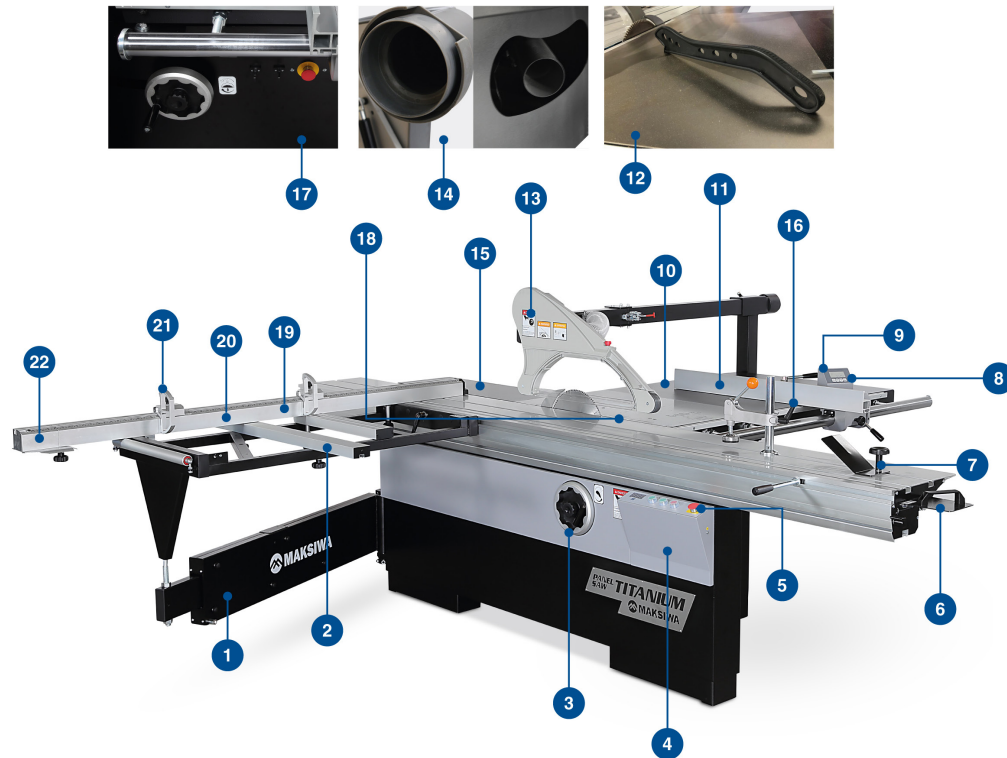
2.2 Components

- | | |
|----------------------------------|--------------------------------------|
| 1. Mobile Arm | 17. Blade Height Adjustment Handle |
| 2. Mobile Table Support | 18. Scoring Blade Adjustment Handles |
| 3. Blade Tilt Control Handle | 19. Measuring Tape |
| 4. Control Panel | 20. Aluminum Table Guide |
| 5. Emergency Buttons/Switches | 21. Wood Panel Stopper |
| 6. Main Table Lock | 22. Aluminium Guide Extensions |
| 7. Wedge Clamp | |
| 8. Digital Display For Rip Fence | |
| 9. Fine Adjustments | |
| 10. Rear Extension Table | |
| 11. Rear Extension Table Guide | |
| 12. Panel Pushing Handle | |
| 13. Dual Blade Protector Cover | |
| 14. Dust Collection Port | |
| 15. Support Table | |
| 16. Wood Panel Clamp | |

2.2.1 Mobile Arm



Enables greater cutting range and greater ergonomics for the operator.

2.2.2 Mobile Table Guide



It is used to support larger workpieces and make cross cuts. Can be placed throughout the movable table.

2.2.3 Blade Tilt Control Handle



It is used to tilt both saw blades manually.
The slope of the saw ranges from 0 to 45 degrees.

2.2.4 Control Panel



At the control panel you control all the functions and cutting devices of the machine.

1. Green button ON: When pressed, it turns on the main blade.
2. Green button ON: When pressed, it turns on scoring blade.
3. Red button OFF: When pressed, the main saw and scoring blade are switched off.
4. EMERGENCY button: This is a safety button. It must be released to operate the main and scoring blades. When it is pressed in the machine turns off.

2.2.5 Emergency Buttons/Switches



The emergency switches are used to power the machine and turn it off.

1. Control Panel EMERGENCY Button: Powers the machine and the machine control panel.
2. Secondary EMERGENCY button. (Cuts power of the machine, located on the side of the main body).

2.2.6 Main Table Lock

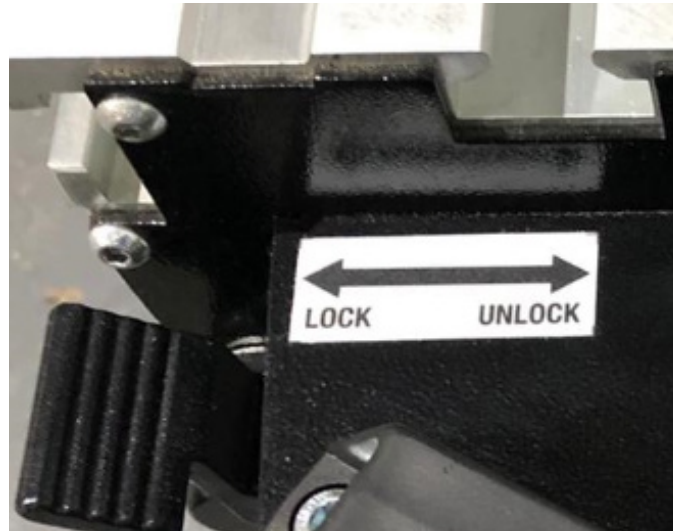

When applied it locks the movable table structure, when released it unlocks the movable table.

2.2.7 Sliding Table Handle



It is used to push the movable table during the cut.
Ensures greater operator ergonomics.

2.2.8 Adjustable Table Handle



It is used to push the movable table during the cut and It can be moved through the table.

2.2.9 Rear Extension Table

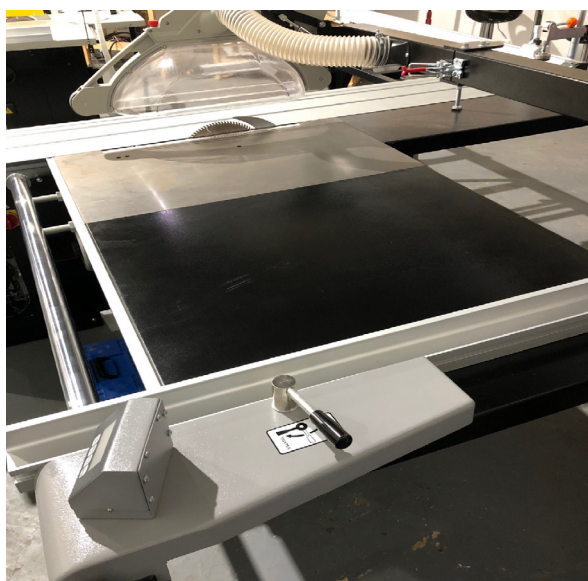

Provides an increase to the work area. It holds a ruler.

2.2.10 Rip Fence

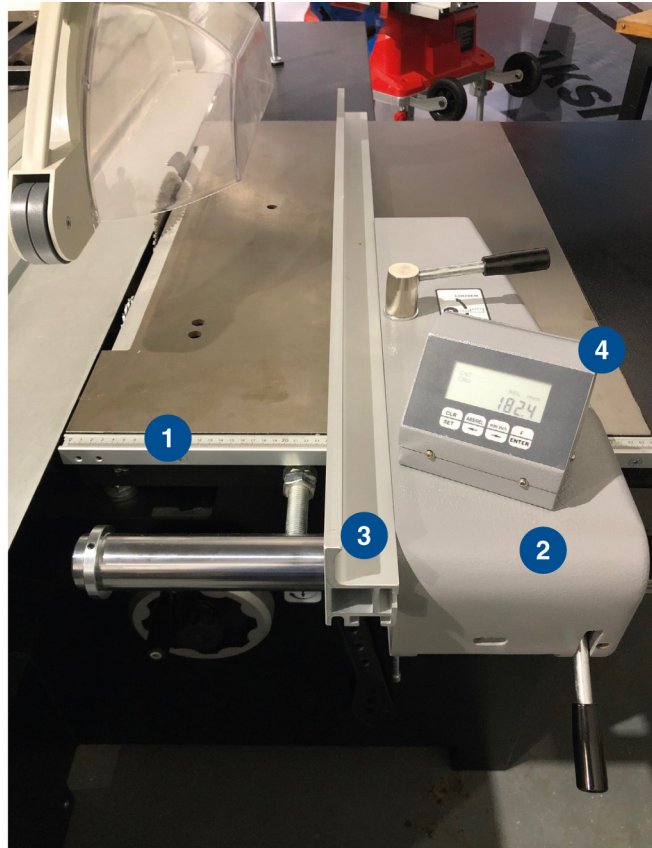

It is intended to be used as a reference to cut multiple pieces at the same measurement.

1. Guide ruler: It is fixed throughout the table.
2. Guide frame: Made of cast iron.
3. Aluminum guide: It is fixed to the guide frame and serves as a support for the workpiece.
4. Digital display provides increased accuracy.

2.2.11 Panel Pushing Handle



It is used to push the workpiece providing safety for the operator.

2.2.12 Blade Protector Cover



It has the function of protecting the operator against splinters and saw dust from cuts.

2.2.13 Dust Collection Port

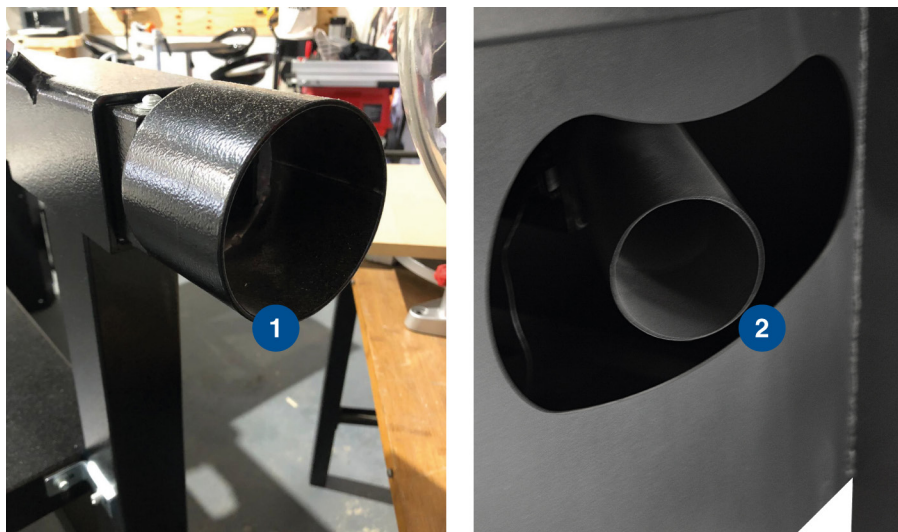

Its function is to collect residues and saw dust from cuts.
The two outputs have a diameter of 100 mm (4 in).

1. Outlet for upper dust collector: It is located in the saw protection cover.
2. Lower dust collector outlet: It is located on the side of the machine.

2.2.14 Support Table



Made of cast iron, it supports internal parts of MDF.

2.2.15 Wood Panel Clamp



It is used to lock work pieces on the movable table.

1. Sheet Clamp
2. Wedge Clamp

2.2.16 Aluminum Table Guide



Made of aluminum, the movable table guide has the function of adjusting the workpiece in the position the operator wishes and It has a ruler.

2.2.17 Scoring Blade Adjustment Location

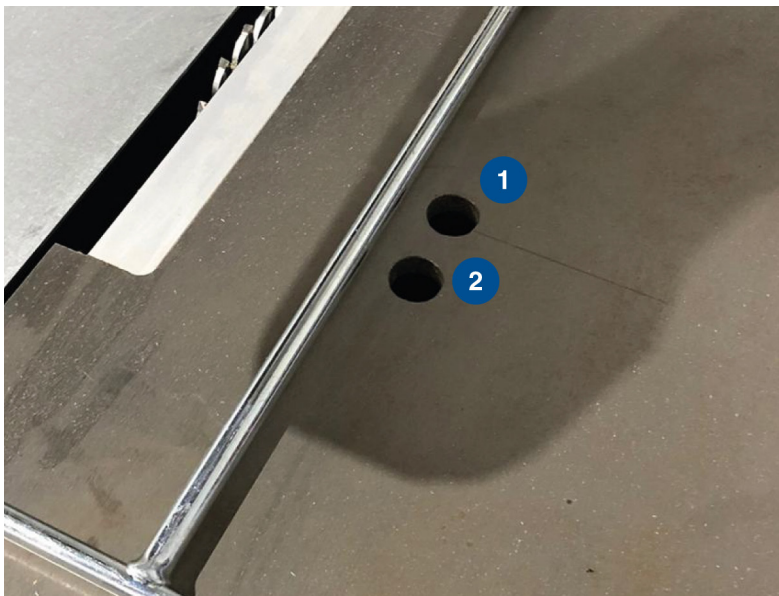

They have the function of regulating the scoring blade.

1. Adjust the scoring blade high. Clockwise = up, counter clockwise = down.
2. Adjust the scoring blade alignment to the main blade (clockwise = out, counter clockwise = in)

2.2.18 Wood Panel Stopper

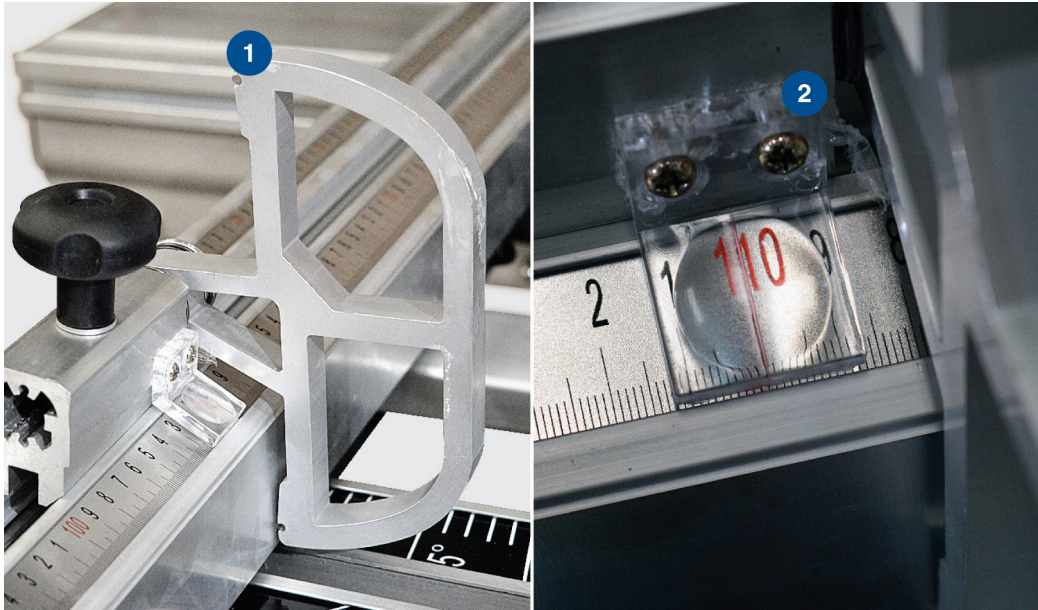

It is located on the aluminum guide of the movable table.

It has the function of locking the workpiece in the position desired by the operator.

Contains 2 units.

1. Workpiece lock: When lowered, it locks the position of the workpiece.
2. Magnifier: Increases the view of the measurement chosen by the operator.

2.2.19 Main Blade Height Adjustment Handle



It is used to raise the main blade height.

2.2.20 Aluminium Guide Extensions

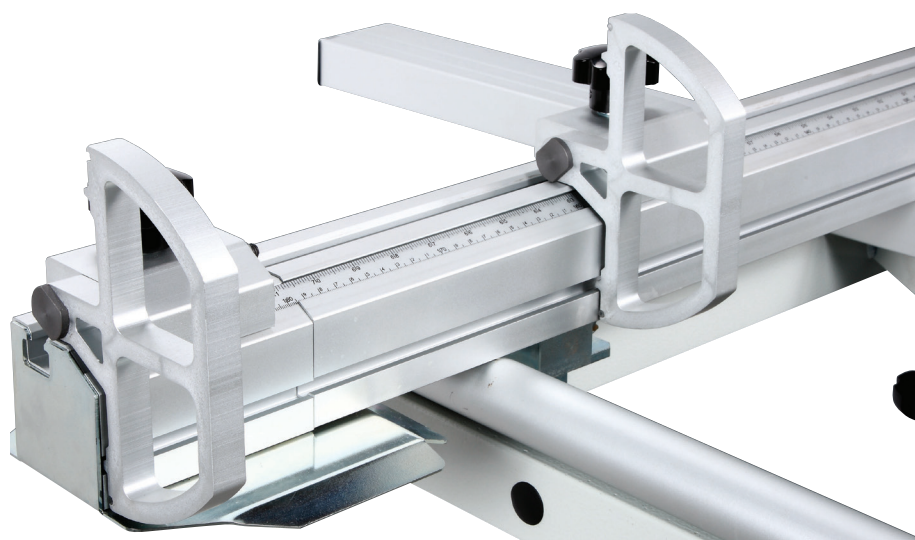

It has the function of extending the work area.

2.2.21 Digital Readout

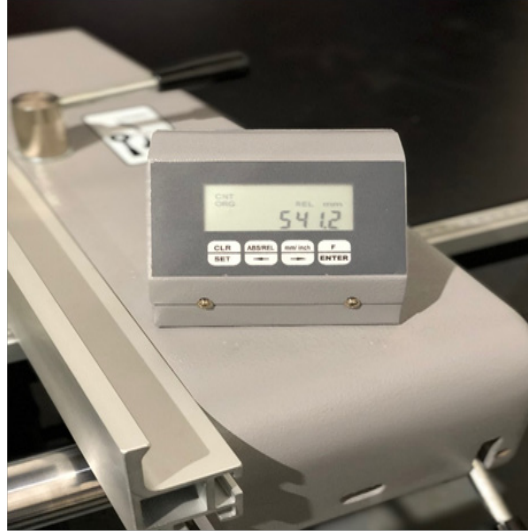



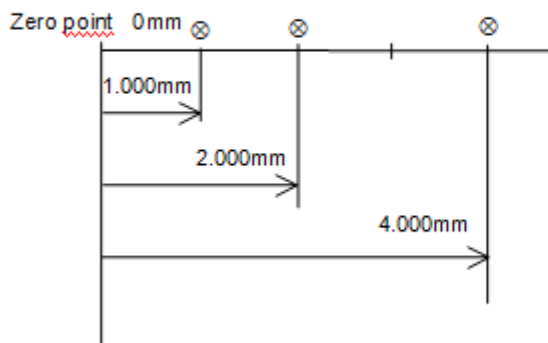
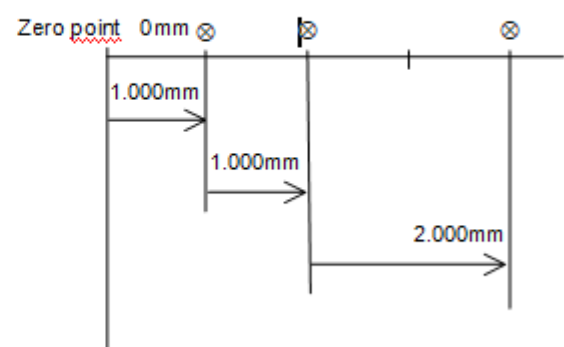

1. Magnetic measuring
2. Battery life 1 year
3. Multifunctional LCD display
4. Resolution 5 μm , 10 μm , 100 μm , 1 mm
5. Max. gap: 2.5 mm
6. Absolute offset counters
7. Programmable offset setting
8. Programmable angular measurement
9. Radial / Diameter mode
10. Programmable coefficient setting
11. Battery level indicator
12. Parameters stored in permanent memory
13. Correct zero point
14. Absolute / Incremental conversion
15. Inch / mm conversion
16. Calibration
17. Real time self-diagnose

Specifications:

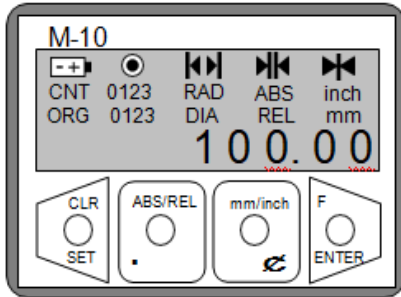

1. 8 digits LCD display
2. Batteries: AA 1.5VDC type x 2
3. Standard cable length: 3M
4. Operate by 4 keys
5. Operating speed: 8m/sec max
6. Repeatability: 0.01mm
7. Accuracy: (+/- 0025 + 002 L) mm
8. Operating temperature: 0°~ +60°C
9. Thermal expansion: $\alpha=16 \times 10^{-6} / \text{k}$
10. Storage temperature: -20°~+70°C
11. Humidity: max95%rF
12. Front panel: 96 w x 72 h x 45 d (mm)
13. Back panel: 91.5 w x 66 h x 40 d (mm)
14. Cut out: 93 w x 67 h (mm)

ABS/REL definition:**ABS (absolute)****REL (incremental)**



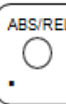

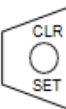
Front Panel and LCD Display:
Keyboard

 When pressed, the symbol  appears on the display

 Select mm/inch/deg mode (deg=degree measurement)

 Select ABS/REL mode

 1. REL mode: clear display value
 2. ABS mode: load origin value
 (Quick load)

LCD display

	Low battery
	Process angular measuring
	The gap is too narrow between sensor and tape
	The gap is too big between sensor and tape
	Enter parameter setting mode (by pressed "F" key)
CNT	REL counter (default)
CNT 0123	REL counter 0/1/2/3
RAD	Radius function
ABS	Absolute mode
inch	Unit: Inch
ORG	Default absolute counter number
ORG 0123	Current absolute counter number
DIA	Diameter function
REL	Relative measuring mode
mm	Unit: mm
100.00	Current position display

Load datum values:

A. Description: To load current value according to working piece.

Ex: The current display position: 100.00mm, the actual position: 200.00 mm

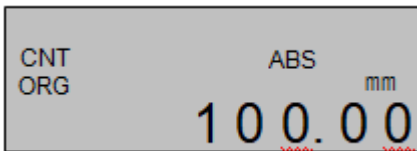

Step 1. Be sure in ABS mode. "ABS" will show on the display.

Note:

1. Press  to switch ABS/ REL mode.

2. If failed to switch, please check F9 (enable / disable key).



Step 2. Press and hold  till  show up.

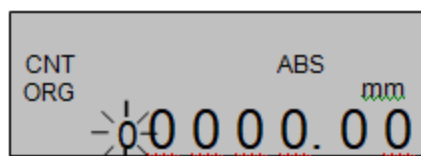

(0 positive / - negative)

Step 3. Press  immediately WITHOUT releasing value.

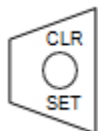

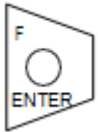

to see the current original.

Press  or  to select/shift digit.

Press  to complete and return to original setting.

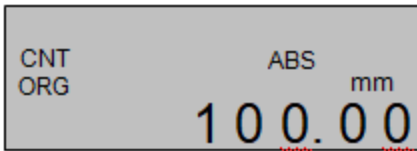
B. Load datum:



Step 1. Press  to enter ABS mode. "ABS" will show on the display.

Note:
1. Press  to switch ABS/ REL mode.

2. If failed to switch, please check F9 (enable / disable key).

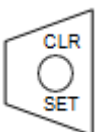

Step 2. Press and hold  till  show up.

Press  immediately and new datum on the display and complete.

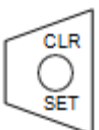
Note: If display "Origin", press  to exit.

C. Troubleshooting:

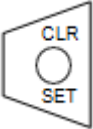

- Display: "Origin" or other words:

Excluding: Press  to exit.

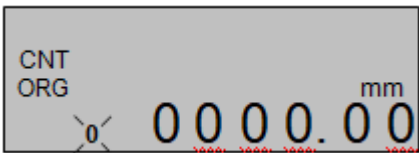

- Display: "0" or digit is blinking:

Excluding: Press  and 

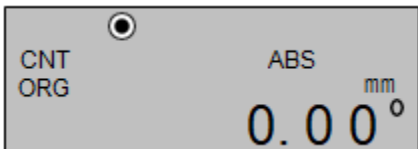

- Display: "0.00°"



Excluding: Press 

Select counting direction (+/-)

Description: To select the counting direction.

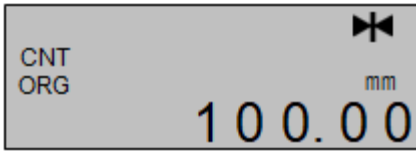
Ex: The current display position: 100.00 mm, the read head move forward and value decrease (99.68 mm) like to increase the value, follow the steps below:



Step 1. Press  and hold till  show up to enter parameter setting (after 5 seconds).





Step 2. Press

Excluding: Press  display "dir".

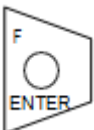
Note: Press  to select parameter.

Step 3. Press  display current counting direction.

Press  or  to select the direction.

Step 4. Press  to complete.

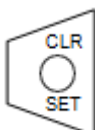

Step 5. Press  to exit.

Note: Please reload origin datum values.

Set device resolution

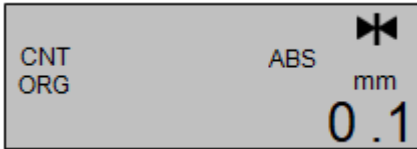
Description: Set M-10 resolution: 1 mm / 0.1 mm / 0.01 mm / 0.005 mm, please follow the steps below:



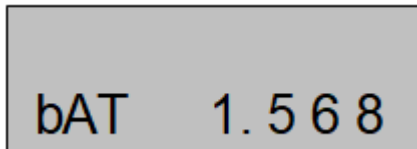

Step 1. Press and hold  till  show up and press 

Note: Please DON'T release  If display origin, press  to exit.

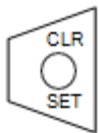

Step 2. It will auto-exit when bat show for 2 sec.

Press  +  at the same time, enter set resolution program.



Step 3. Press  to select resolution.

Sequence:

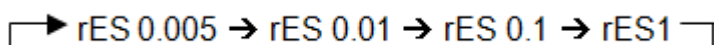



Step 4. Press  to exit.

Note: Please kindly confirm the resolution.



Pre-set 4 programs

A. Description: M10 provides 4 programs (ABS) for user to pre-set cutting length and count accordingly.

Ex: P1 = 20 mm, P2 = 30 mm

ORG: Default, offset: 0 ORG 1 / 2 / 3



Step 1. Press and hold  till  show up.

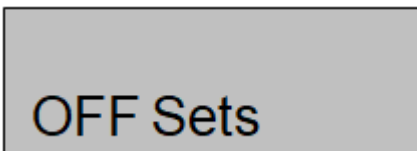

Step 2. Press  LCD display Offsets.

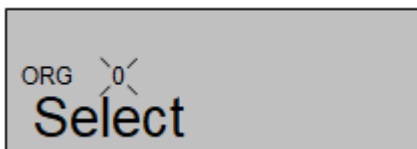

Step 3. Press  to enter parameters function.

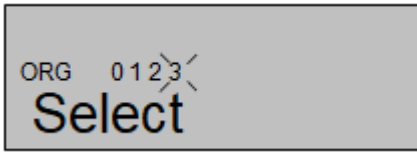

Step 4. Press   to select.



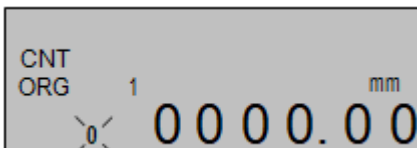

Step 5. Select ORG1 → P1

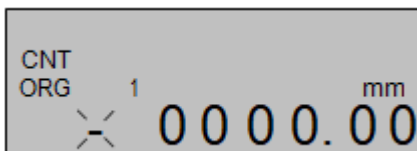

Step 6. Press  (0 or — blinking).

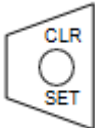

Step 7. Press  to select +/- or set numeric. Press  to shift.

Note: Select  → —

Step 8. Confirm the numeric. Press  returns to ORG.

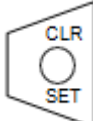
Step 9. If proceed to set, please repeat step 4 ~ 8. Press  twice to exit.

B. Execute pr-set programs (**Only in ABS mode**)

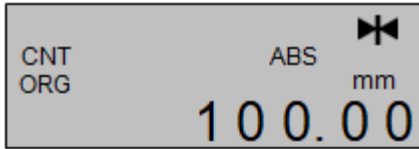

Step 1. Press and hold  till  show up. Press  to select ORG.

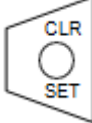
Note: If display origin, press  to exit.



Set speed

A. Description: Provide 6 mode of speed: SPEED 0 / SPEED 1...SPEED 5 Low speed, low battery life.

Parameter	SPEED 0	SPEED 1	SPEED 2	SPEED 3	SPEED 4	SPEED 5
Speed (mm/sec)	0.27	0.41	0.82	1.63	3.29	8.33
Battery life (years)	2.78	2.56	2.28	1.83	1.42	0.95

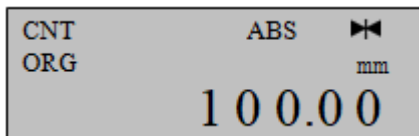
B. Operation step



Step 1. Press  and hold till  show up to enter parameter setting (after 5 sec.).

Display: Origin (Adjusting parameter)



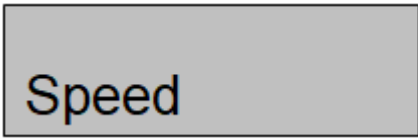

Step 2. Press  four times, display Speed.

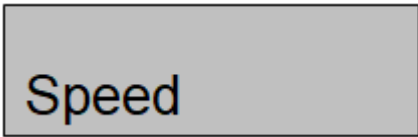

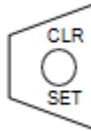
Step 3. Press  display origin parameter. (Confirmed Speed 3). Press  to select speed.

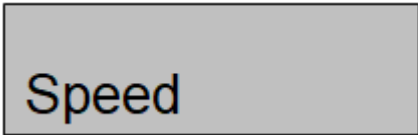

Step 4. Press  to display Speed.

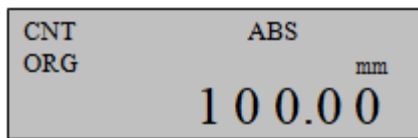

Step 5. Press  to exit.

Calibration (Adjust gap between sensor and tape)

A. Description: For better accuracy, please execute "Setup" function immediately after installed sensor each time.

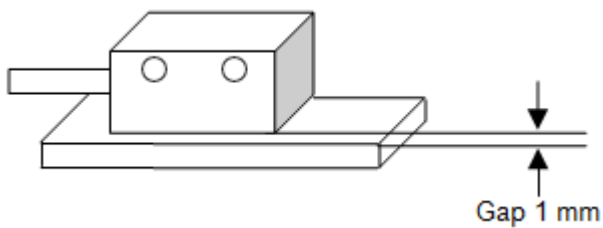

Step 1. Fix sensor, keep 1 mm gap from tape. (RECOMMENDED).

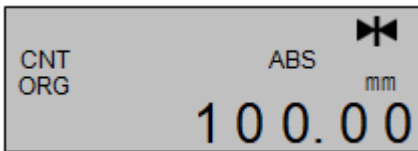

Step 2. Press and hold  till  show up to enter parameter setting.

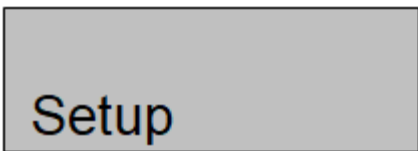

Step 3. Press  till display "Setup".

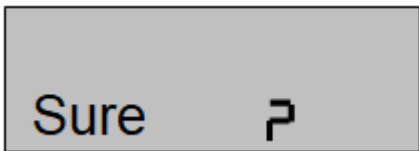

Step 4. Press  to confirm enter parameter.



Step 5. Press  to calibration.



Step 6. Moving the slider at low speed. (Required distance around 120 mm).

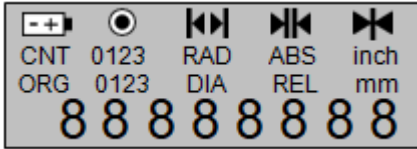

Step 7. When completed, all symbols and digits will blink and return to the operation display.

Note: Please execute load datum values immediately.

B. Troubleshooting:



Display: Sensor and Possible cause: The gap is too small. Excluding: Increasing gap and press

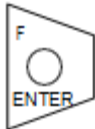

twice and repeat step 6 to complete.

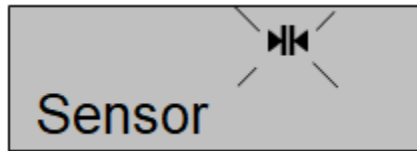

Display: Sensor and Possible cause: The gap is too big. Excluding: Decreasing gap and press



twice and repeat step 6 to complete.

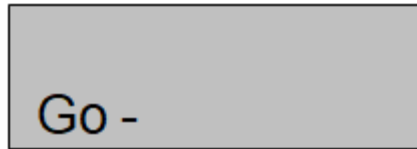

Display: Go / Go- / Go-- Possible cause: 1. Gap is too big. 2. The mounting surface is Not flat.

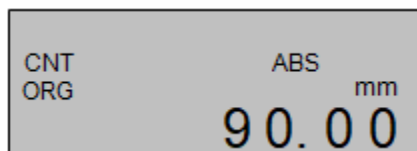

Press to exit or end during calibration.

Enable and Disable Specified Parameter

Description: Select enable and disable parameter, follow the steps below:

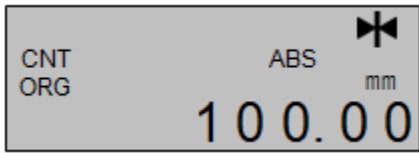

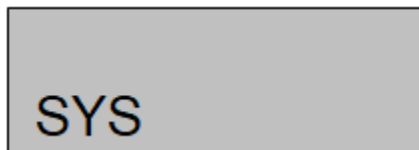

Step 1. Press and hold  till  show up to enter parameter setting.

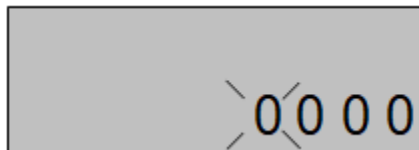

Step 2. Press  and hold till SYS show up.

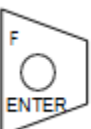

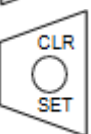

Step 3. Press  and enter password: "2201" (Digit is blinking).

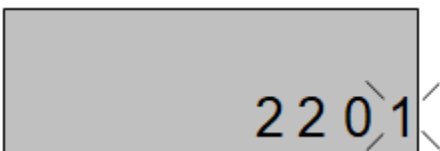
Step 4. Press  to set value. Press  to select digit.

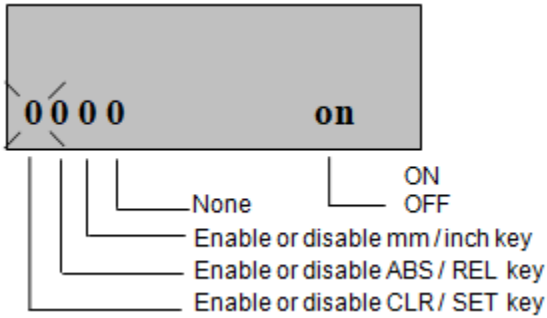

Step 5. Please confirm the password. Press  and enter parameter function.



Step 6. Press  to switch on / off. Press  to select parameter.

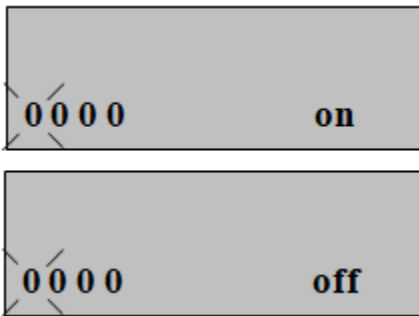

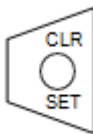
Step 7. Press  to select on / off.

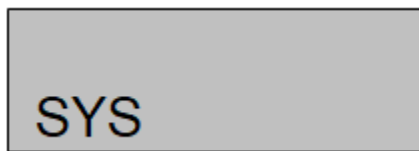



Step 8. Press  and display SYS.

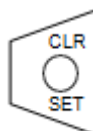

Step 9. Press  to exit.

Parameter Setting

Step 1. Press and hold  till  show up.

Step 2. Press  to select parameter. Note:

1. To switch Origin / dir / SYS / REL.

2. Press  to exit.

Appendix - Parameter

Parameter	Display	Description	Default	Remarks
1	Origin	Load datum value	0	
2	Direction	Select counting direction (\pm)	dir - -	
3	Off Sets	Set tool diameter	0	
4	Angular	Enter semidiameter value	0	
5	Scaling	Diameter / semidiameter	rAd	
6	Linear Correction	Linear correction	1.00000	
7	Speed	Speed	3	
8	Setup	Fine adjustment distance		
9	SYS	Enable/disable Parameter	0000	
10	REL	Software version		

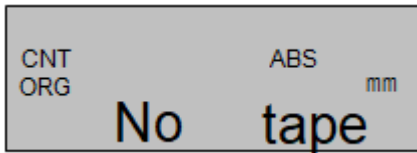
Troubleshooting

- A. Display: no tape. Possible cause: The gap is too big. Excluding:
- Please check the gap between sensor and tape. Refer “Calibration”.
 - Sensor over the travel.
 - Tape is loose.
 - Refer “Installation guide”

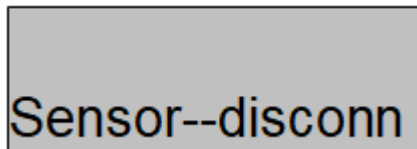

- B. Display: Sensor disconnected. Possible cause: No sensor Excluding:
- Please check the 8 Pin connector.
 - Wire broken.
 - Take off the battery (wait 10 sec) Re-install.

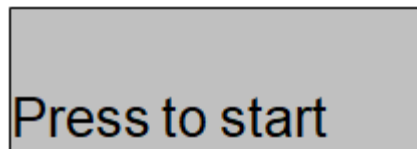

- C. Display: Press to start Setup Possible cause: No sensor Excluding:

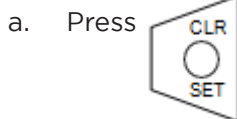

- Refer “Calibration”
- Loose contact.
- Chang the wire and sensor.



- D. Display: 0-1.00 mm. Possible cause: No sensor Excluding:
- Wire broken.
 - Sensor broken.
 - Change the wire and sensor.



- E. Display: Enable. Possible cause: Low battery. Excluding:
- Please replace the batteries.



- F. Display:  Possible cause: Low battery. Excluding:
- Change the battery.
 - M-10 will lose current value.
 - Refer to “How to change battery.

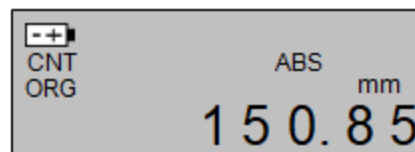

- G. Display: Digit is blinking. Possible cause: Low battery. Excluding:
- Change the battery.
 - Refer to “How to change battery.
 - Measurement error.

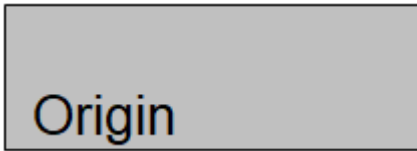

H. Display: "Origin" or other word. Possible cause: Enter parameter function. Excluding:

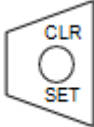
- a. Press  to exit.

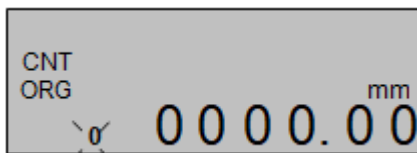

I. Display: "o" or other digits and blinking. Possible cause: Enter parameter function. Excluding:

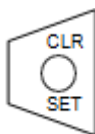
- a. Press  and 

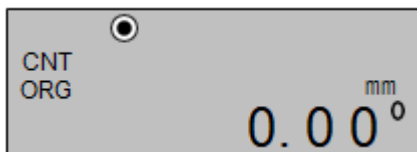

J. Display: "0.00". Possible cause: Enter angular mode. Excluding:

- a. Press  to exit.

How to change battery

Battery type: AA (1.5V) x 2 pcs. When LCD displays with  symbol, please change 2 new batteries to ensure M-10 performance normal.

- A. Release the screws back of battery holder and remover the cover.

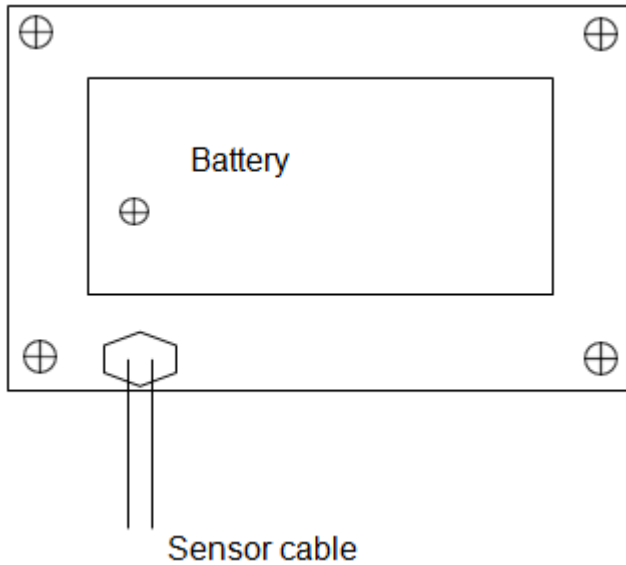

B. Slide the cover to left.

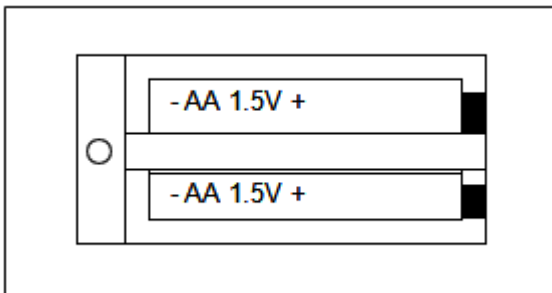

C. Strongly recommend to replace battery one by one.
Please Do Not change 2 batteries at the same time. It will cause M-10 lost current value. All parameters will be stored.

D. After change battery, please lock the cover.

Note:

1. If lost current value, please reload origin datum values.
2. Battery: 1.5V DC AA type x 2 pcs.

Installation Guide

The magnetic tape consists of three components:

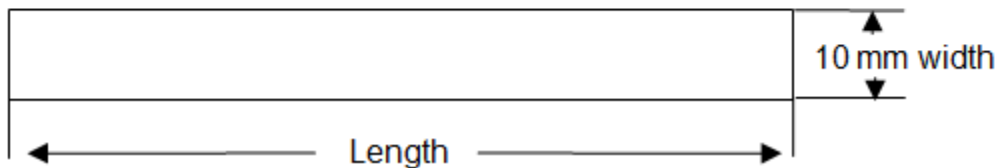
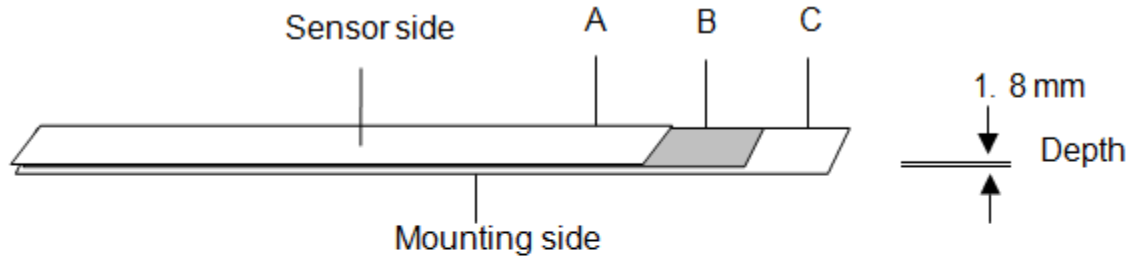

- A. A magnetized, highly flexible synthetic tape.
- B. Flexible steel tape. A and B are already factory-bonded.
- C. To keep the flexibility for transport and installation, the third part C, also a steel tape is delivered separately. It serves for mechanical protection of the synthetic tape and must be stuck on the magnetic synthetic tape after installation.
- D. There components of tape: depth: 1.8 mm, width: 10 mm.

Installation:

- a. Ensure to apply tape on clean, dry and plain surface.
- b. Be sure the tape adhesion on surface.
- c. Please apply the tape with ambient temperature: 21-38°C
- d. We recommend to make a chamfer on the machine to install the tape.
- e. If cut a edge can stable the tape.

Cable:

- Distance more than diameter 50 mm.
- Must be away from inductive and capacitive interference source as conductor, relays, motors, switch power pack clocked controllers, etc.
- Must be kept a distance to interference sources.

Sensor:

- Allow some fault when install the sensor.
- Attend the position when install the sensor.

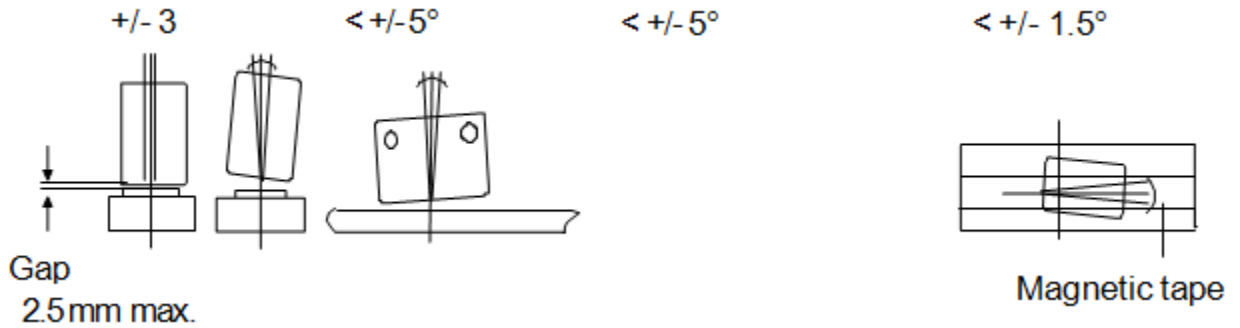

Recommend Gap between tape and sensor: 1 mm

Unit: mm

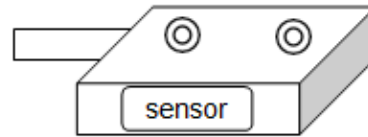
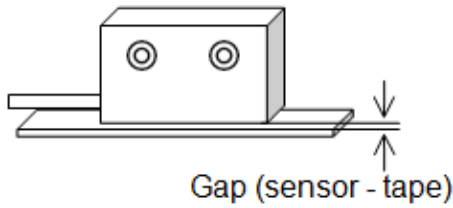

※Attached the sensor on the tape with "senor" sticker.

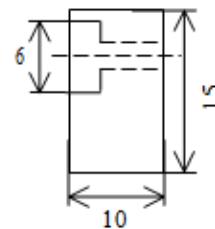
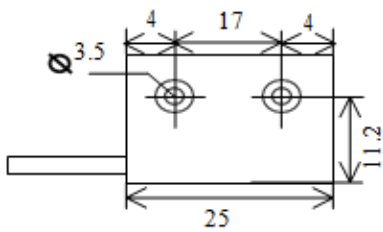

External dimension

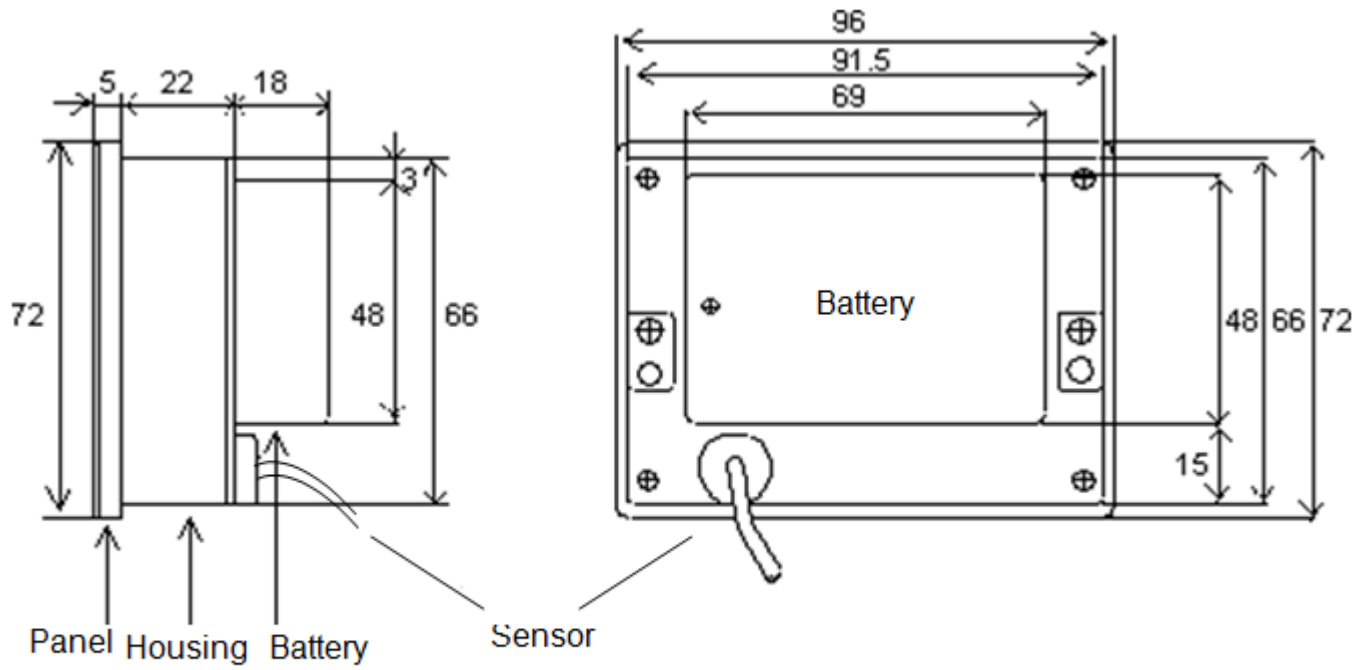

(Unit: mm)

Mounting drawings

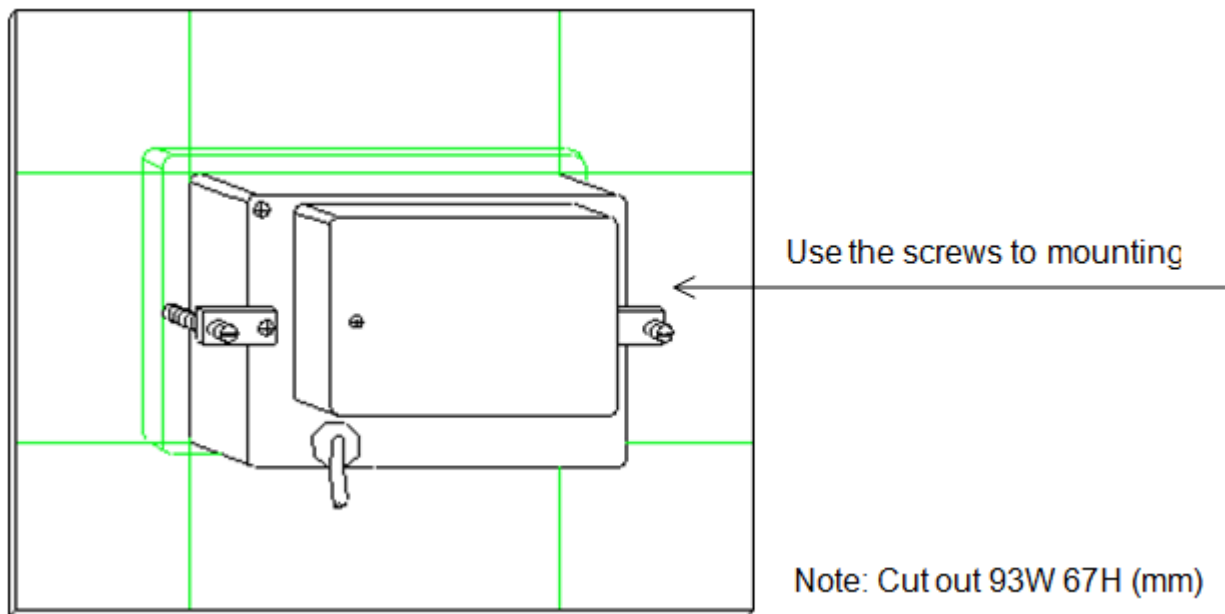

3 Installation

The following sections will deal with the adjustments necessary for the smooth operation of the machine and shall refer to the term that accompanies the illustrations. For this, you must know the components and know where they are.

3.1 Electrical Installation

- The electrical installation should be carried out by qualified and trained personnel.
- The main connections must be made at the terminal box.
- Installation of the power cord in the machine should only be done by a electrician.
- Connect the machine's power wires to an electrical outlet: 220 V.
- We recommend the installation of circuit breaker be according to the model you have purchased.



Fig. 1: Access the power supply box, add main wire 220V.

Fig. 2: The configuration should be from left to right. L1, L2 and ground. Once all wires are hooked up, turn on main power switch.

Fig. 3 and 4: If it does not start up check the emergency buttons, the front panel or the rear access door. If rear door or red blade guard is open, blades will not spin.

Electrical:

Single phase models:

1 phase model 220 V:

Main motor:

- 24 Amps
 - 5 HP
 - Non loaded blade speed: 4000 RPM
- Scoring motor:
- 6 Amps
 - 3/4 HP
 - Non Loaded blade speed: 8000 RPM

It is recommended to consult an electrician.

If your model is a 1 phase 220 V we recommend a 30-amp circuit breaker.

Use a minimum 12 to 10 gauge wire.

CAUTION: To prevent electrical shock, any maintenance or repair to the electrical system should be done only by a trained electrician using OEM parts.

CAUTION: Do not connect the unit to the power outlet until this manual is read and understood.

3.2 Assembly

- For packaging reasons, the machine is not completely assembled.
 - If you notice any damage caused by shipping, while opening the package, notify your supplier immediately. Do not operate the machine.
 - Estimated assembly time: 2 to 4 hours.
1. Carefully remove the machine from the crate and any loose components in the interior of the machine, then remove plastic coverings from all components.



Fig. 1 and 2: Unpacking the machine.

Fig. 3 and 4: Removing the components.

2. Remove all the Allen bolts from the Support table. After that, install the cylindrical bar of the fixed table.

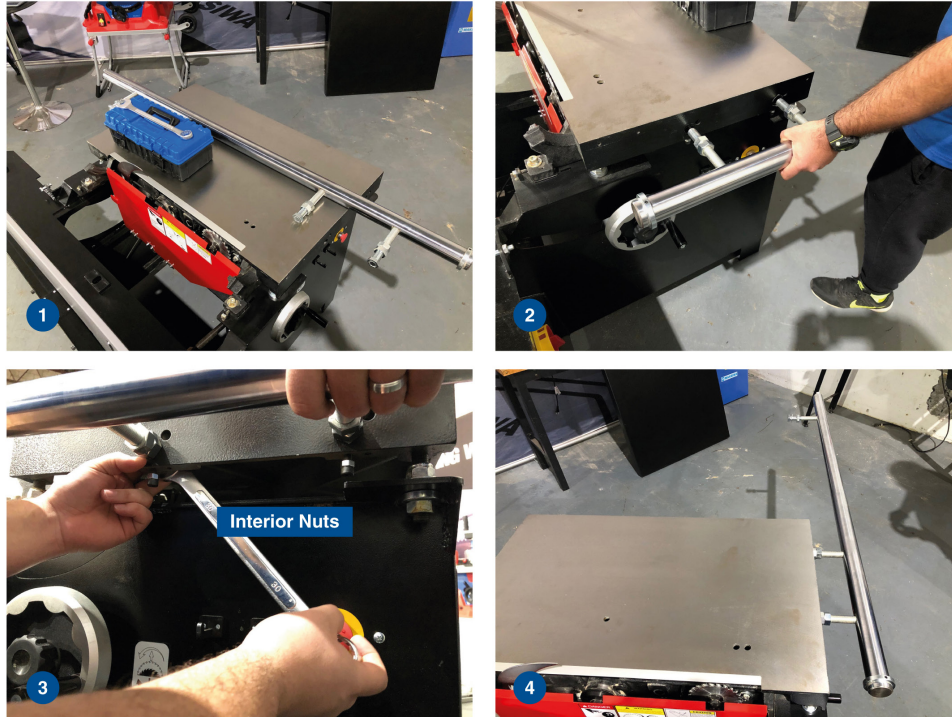

Fig. 1: Inside the tool box (included) use the 30 mm Combo wrench to tighten the interior nuts.

Fig. 2: Place the rail on the correct position.

Fig. 3: Tighten the nut on the inside of the machine.

Fig. 4: Rail fixed.

3. Install the rear table.



Fig. 1: Use three bolts washers and lock washers to fix the rear table on the main body of the machine.

Fig. 2: Remove one nut and one washer from the far end of the round rail.

Fig. 3 and 4: Place table on the correct position.

Fig. 5 and 6: Tighten three bolts under the table and make sure it is leveled.

4. Install lower arm, standing support arm and upper arm.

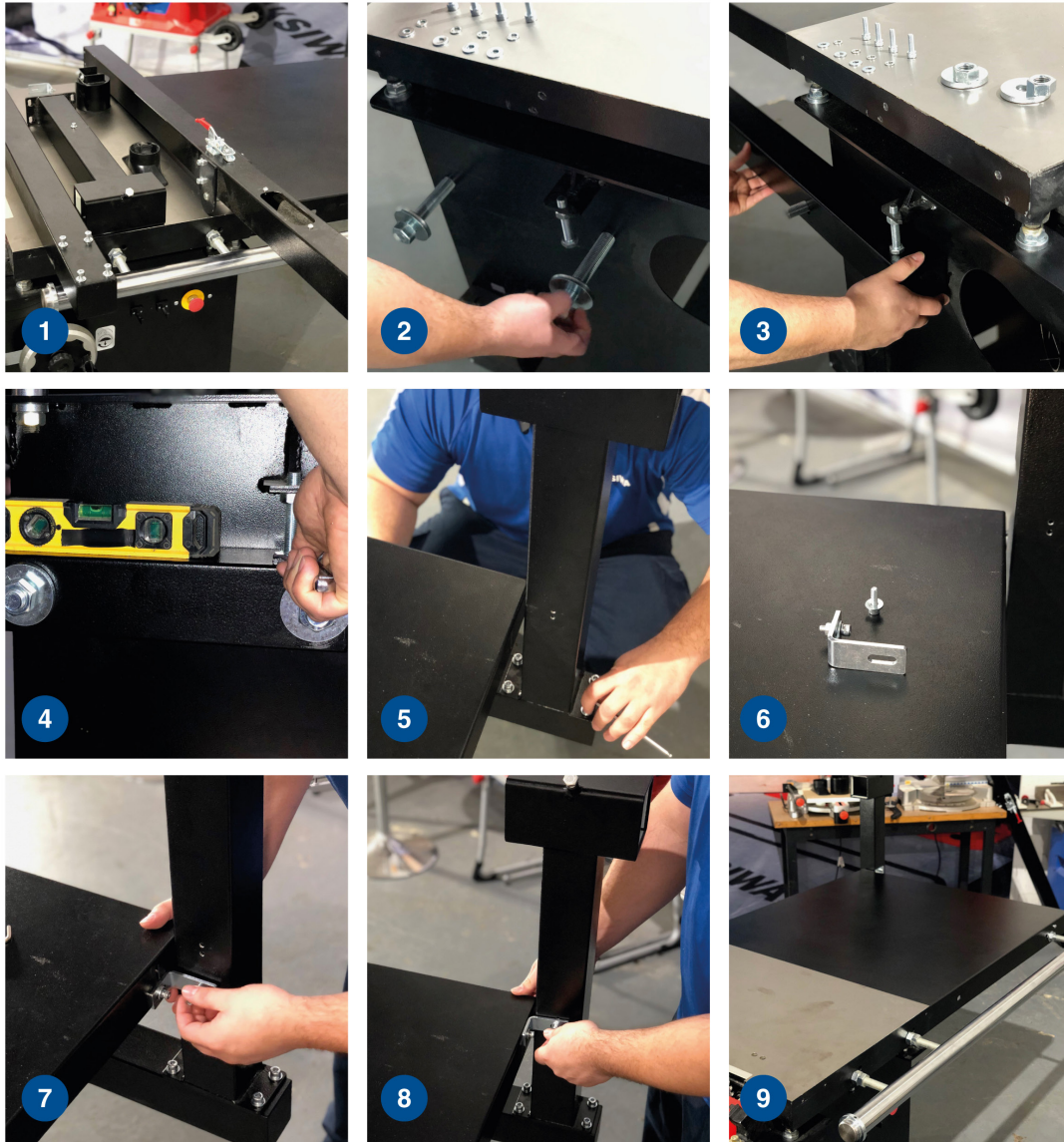

Fig. 1: Separate all parts needed.

Fig. 2 and 3: Remove mounting bolts and install lower arm.

Fig. 4: Make sure arm is leveled and tighten mounting bolts (don't tighten all the way, so you may make adjustments as needed. Once adjustments are completed, tighten all the bolts).

Fig. 5: Install standing support arm.

Fig. 6, 7 and 8: Add brackets and finish tighten all bolts.

Fig. 9: Standing support arm installed.

5. Install the upper arm and dust collector ports.

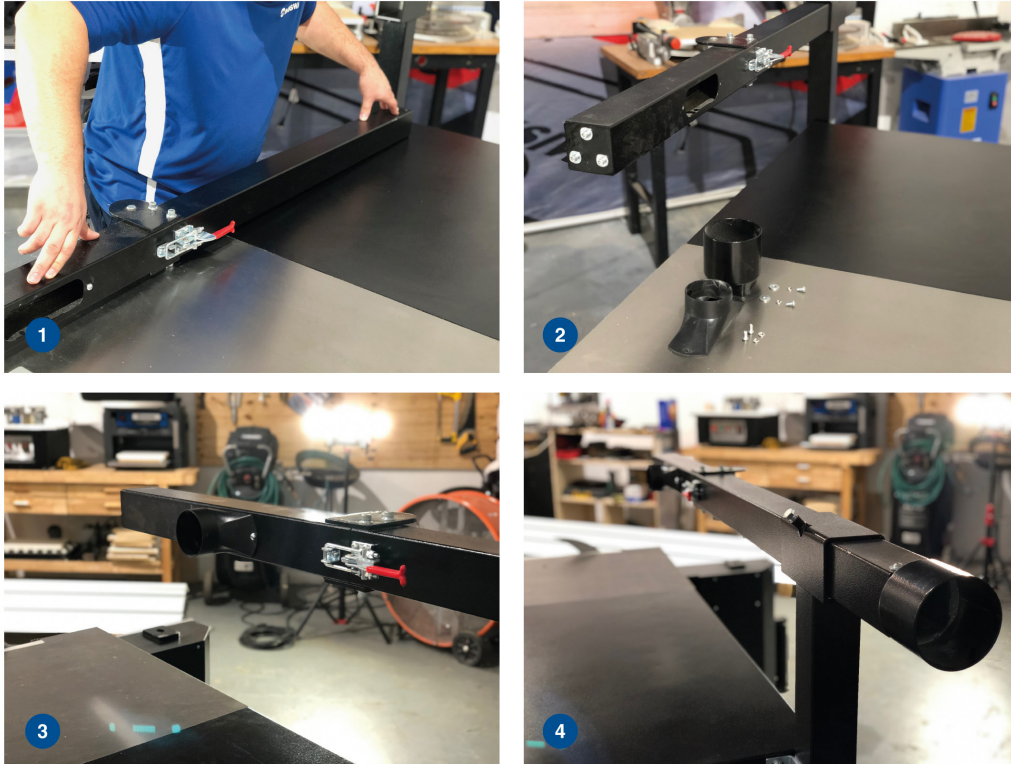

Fig. 1: Attach upper arm on standing arm support.

Fig. 2: Install dust collector ports.

Fig. 3 and 4: Tighten all bolts.

6. Install the Support table ruler.

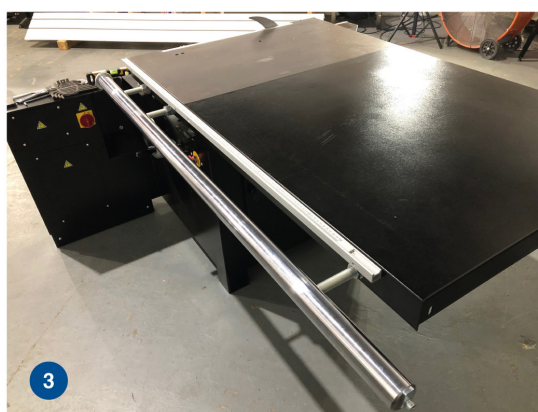
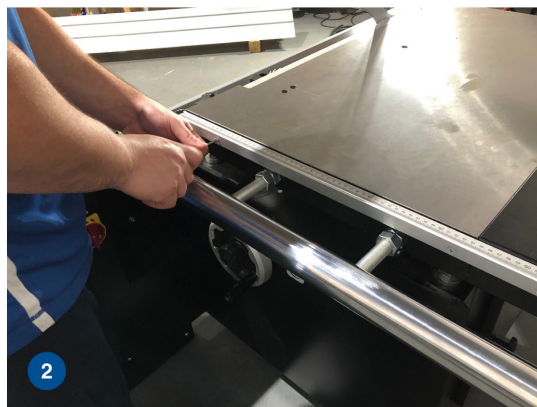

Fig. 1: Position the ruler guide on the support table.

Fig. 2: Tighten the bolts.

Fig. 3: Installed guide.

7. Install rip fence and rip fence tape.

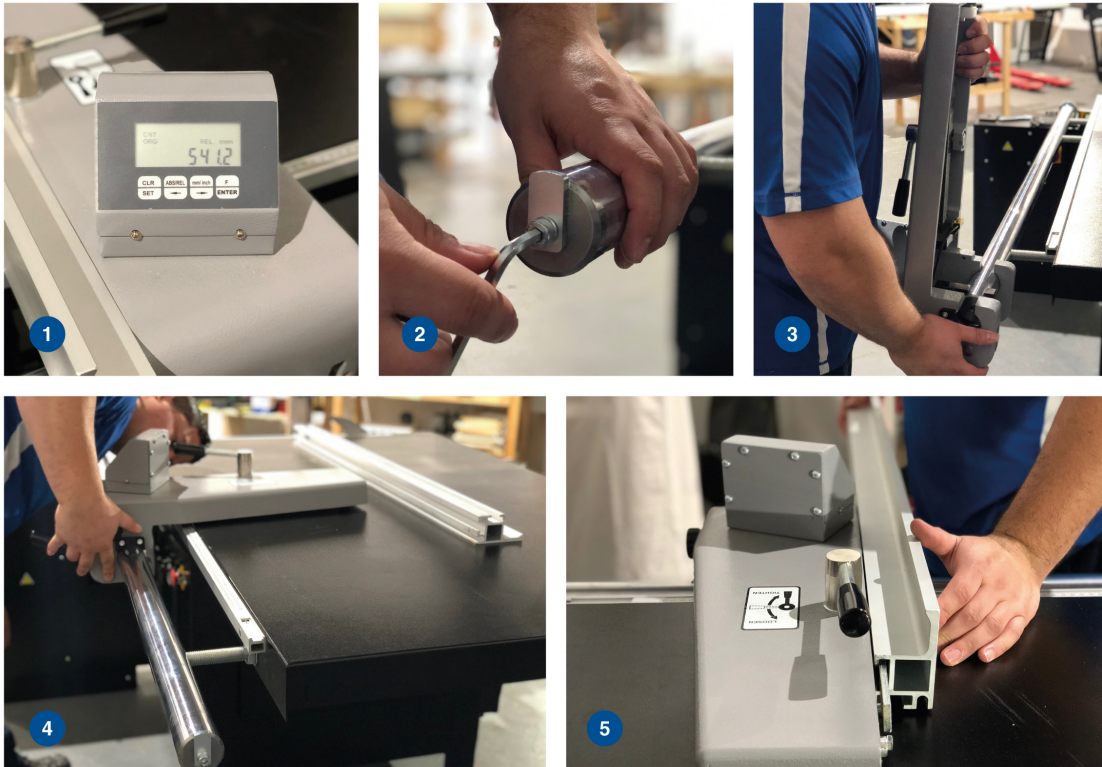

Fig. 1 and 2: Add rip fence by into the side rail, by removing rear stopper.

Fig. 3 and 4: Slide rip fence into place and reinstall the stopper back.

Fig. 5: Install rip fence tape. start install the fence from the back, loosen lock handle.

8. Install side table.

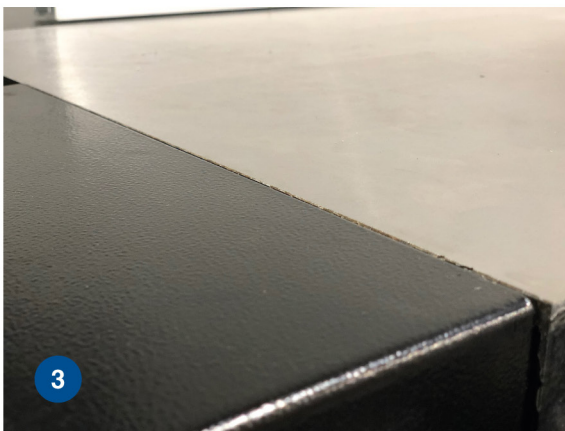
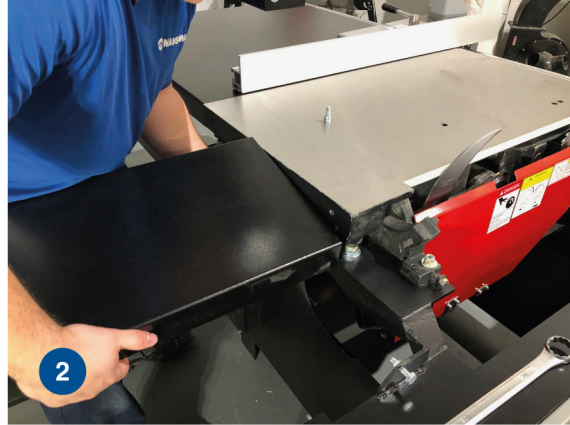
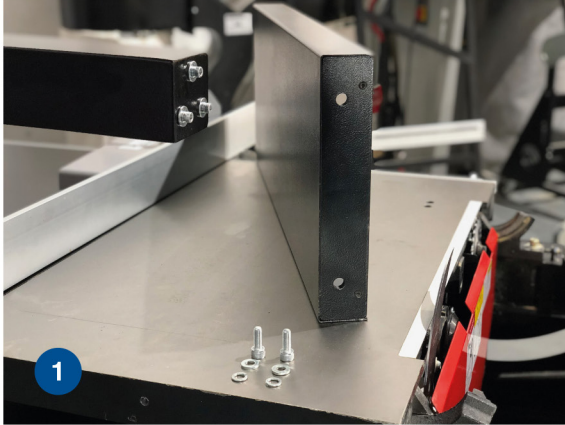

Fig. 1, 2 and 3: Align side table with main body of the machine. Make sure it stays flush.

Fig. 4: Tighten two allen bolts.

9. Install main blade.

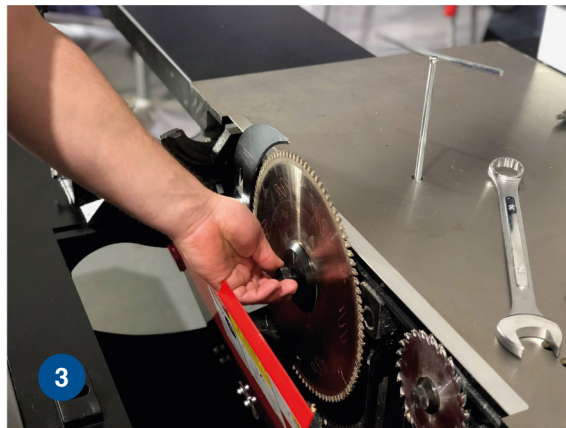
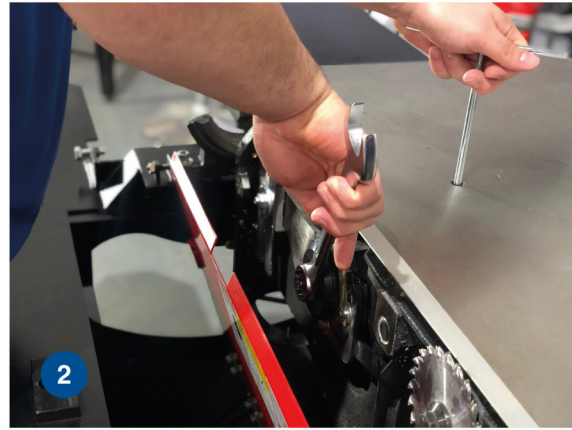
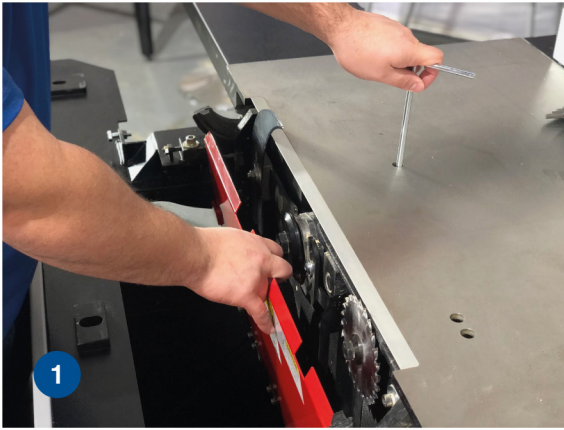

Fig. 1 and 2: Hold it down from the top and loosen side nut clockwise.
Fig. 3 Tighten the nut.

10. Install the sliding table.

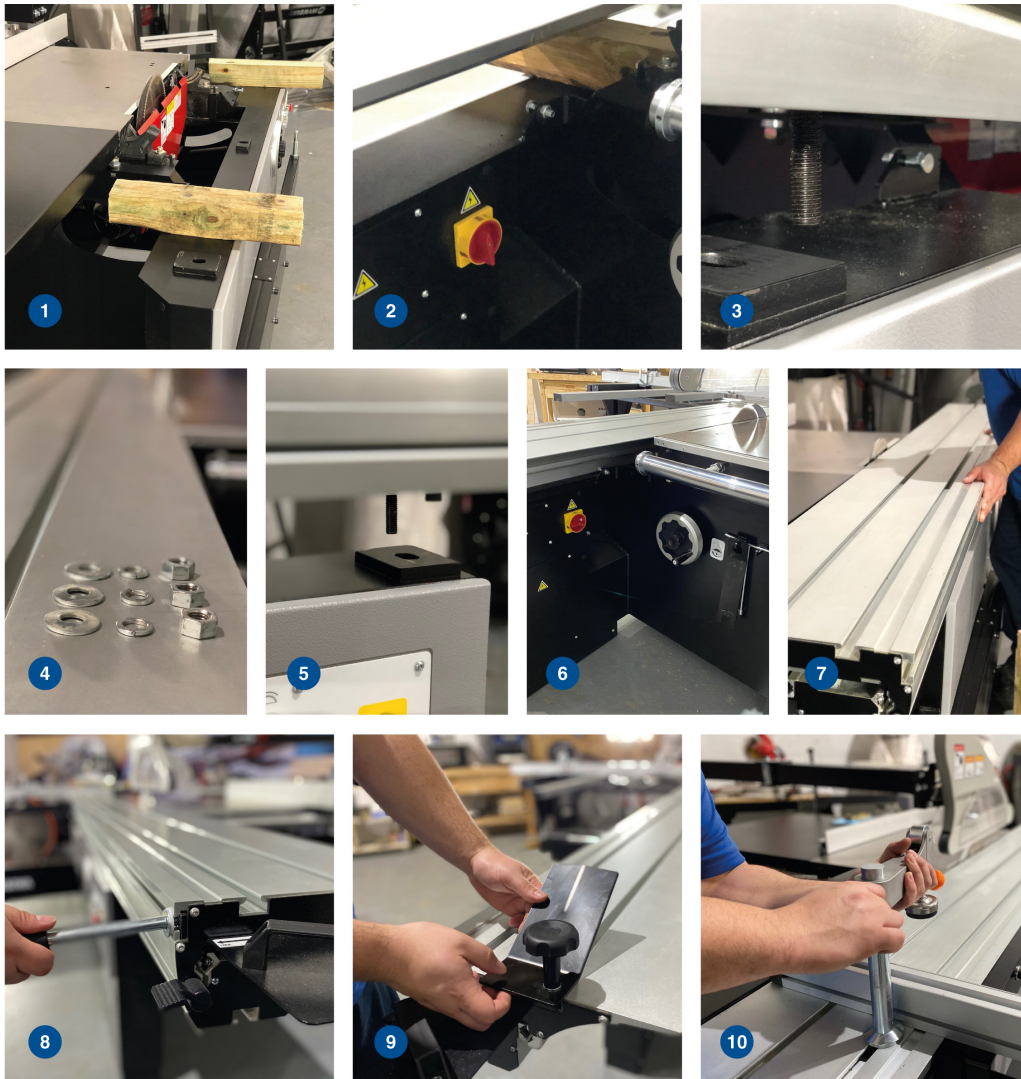

Fig. 1: Add two 4x4 wood pieces where the sliding table will be.

Fig. 2: Make sure table is in lock position and place it on top of the wood pieces. (Do not touch the alignment bolts over the shut off button, this was already set on the factory).

Fig. 3 and 4: Align bolts with the holes to be tightened. Remove wood pieces one by one, once all out push the table against the alignment bolts.

Fig. 5: Add the three nuts, three washers and three lock washers on the table bolts.

Fig. 6: Remove the upper electrical port to access the bolt. Once the table is aligned tighten all 3 bolts.

Fig. 7: Table is installed.

Fig. 8: Install side handle on sliding table.

Fig.9: Install wedge clamp.

Fig.10: Install sheet clamp.

11. Install the saw guard into the frame.



Fig. 1 and 2: Attach the saw guard to the frame.

Fig. 3: Install dust collection hose.

Fig. 4: Tighten all bolts.

Fig. 5 and 6: Installed protector.

12. Install support table.



Fig. 1: Attach the support table on the lower arm.

Fig. 2 and 3: Install the adjustment bracket on the fence and tighten bracket.

Fig. 4: Install handles to fence brackets, but do not tighten completely.

13. Fence adjustment.

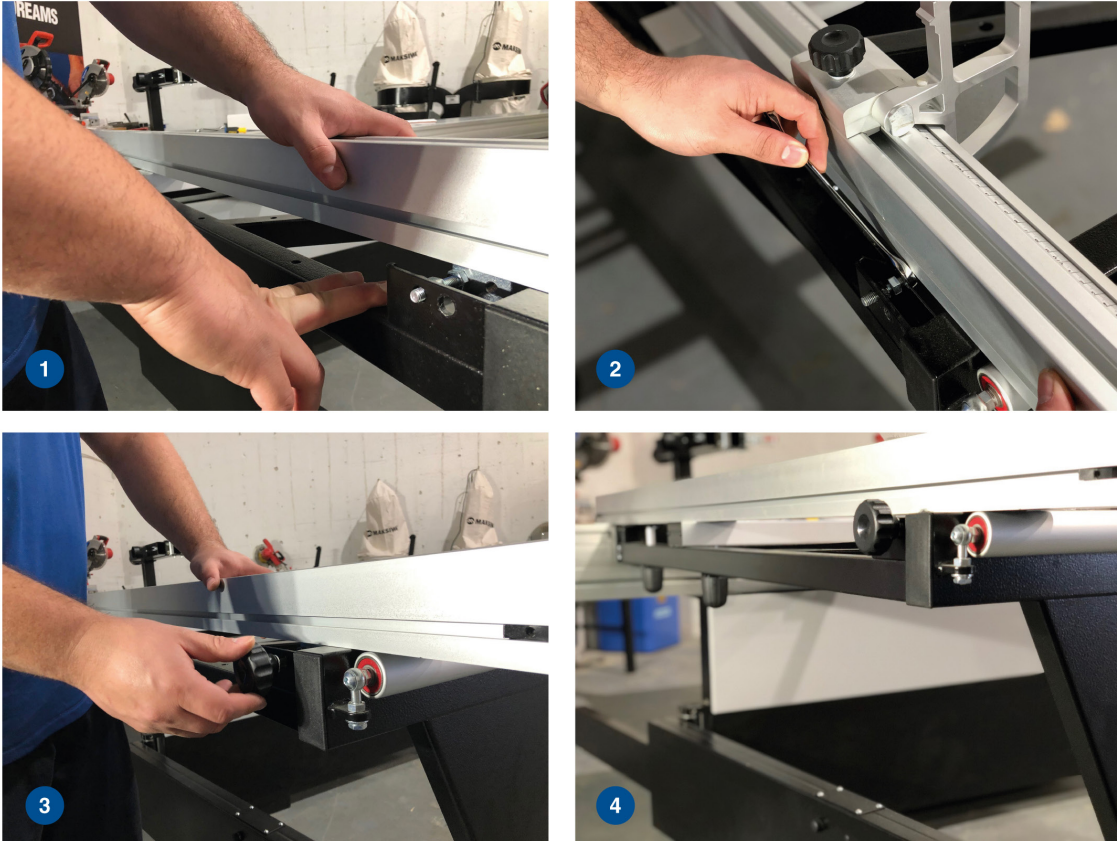

Fig. 1 Slide fence to the 90° stop bolt and check for alignment .

Fig. 2 If necessary adjust 90° stop bolt until fence is squared.

Fig. 3: Install knob on the square block and tighten until the 90 bolt and block are touching. Do not over tighten.

Fig. 4: Table installed.

14. Wood Panel Stopper.

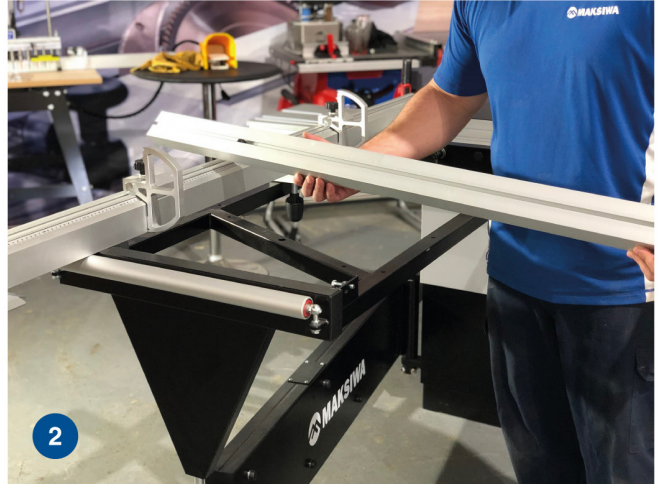
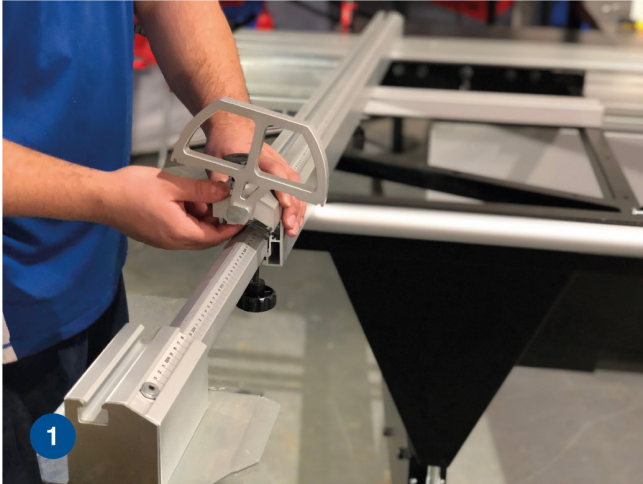

Fig. 1 and 2: Fit the wood panel stopper on the aluminum tab and tighten the handles.

15. Ready! Your BMT.3200.IR Titanium Precision Saw is properly installed.



4 Operation

- Before operating the machine, make sure that the electrical installation was properly installed.
- The electrical installation should be done by a trained electrician.
- NOTE: Although your saw cuts wood and many other non-ferrous materials, we will limit ourselves to discussing only the cutting of wood. The same guidelines apply to other materials.
- DO NOT USE ABRASIVE BLADES.
- The smoothness of any cut depends on a number of variables. Factors such as the type of material being cut, blade type, blade sharpness and cutting rate contribute to the cutting quality.
- When you want smoother cuts for frames, install a sharper blade (80 or more carbonated teeth). A slower and steady cut rate will produce the desired results. Make sure that the material does not vibrate during the cut.
- The BMT.3200.IR Titanium cuts internal MDF sheets.
- Proper positioning of the body and hands during operation will make cutting easier, accurate and more secure. Never place your hands close to the cutting area. Put your hands in position no closer than 6 inches from the blade. Hold the piece firmly against the table and the guide during cutting.

4.1 Main Blade Adjustments

Lift the cutting blades by turning the handle counterclockwise. The saw has to be approximately 20 mm (3/4 in) from the height of the sheet to be cut.



Fig. 1: Saw blade raise handle.

Fig. 2: Illustration of the height of the saw blade in relation to the workpiece.

4.2 Scoring Blade Adjustments

The function of the scoring system is to perform a surface cut, such as a “scratch” on the workpiece before the main blade cuts. This allows the cut to come out clean, with no chips on the workpiece. It is an optional system; the operator can choose to work with it or without it. To use it first, lift the cutter by turning the left knob counterclockwise. The height should approximately be 5 mm (3/16in) above the table.



Fig 1 and 2: Scoring blade adjustment location. Adjust the scoring blade height. Clockwise = up, counter clockwise = down. Adjust the scoring blade alignment to the main blade (clockwise = out, counter clockwise = in).

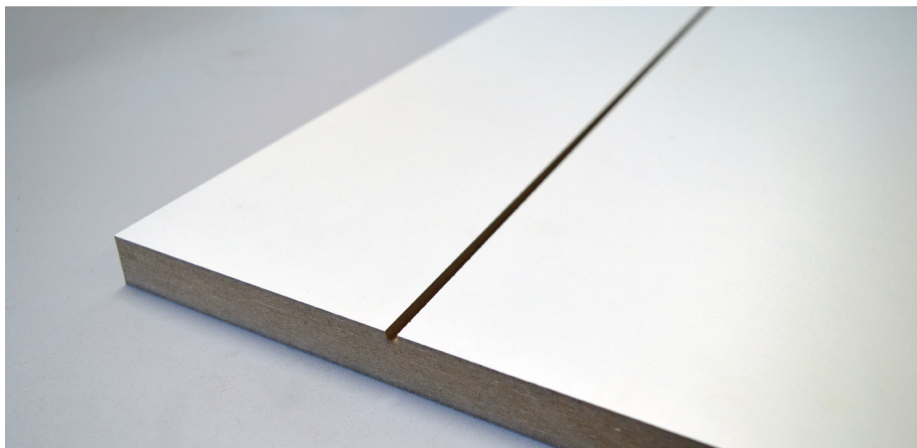

Your alignment should look like this.

4.3 How to Cut at Different Angles

The BMS.3200.IR Titanium can cut up to 45 degrees. To do this, turn the handle located on the front of the machine to the desired angle and check the angle on the digital display.

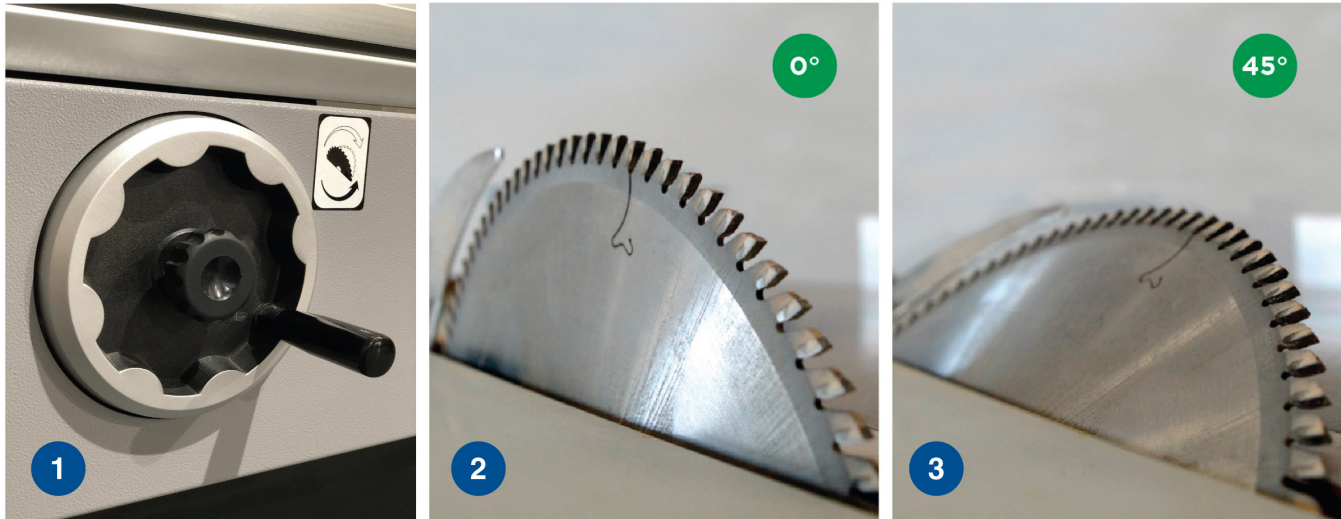

Fig. 1: To tilt blades loosen center knob and pull out handle. Turn clockwise to tilt 45, turn counter clockwise to go back to 0.

Fig. 2: Tilted 0 degrees.

Fig 3: Tilted 45 degrees.

4.4 How to Setup for Recurrent Cuts

Choose the measurement of the workpiece that you want to cut.

Lock the fixed table guide. Then push the piece against the table guide, If the operator wishes, he can secure the workpiece using the wood panel clamp.



Fig. 1: Wedge clamp.

Fig. 2: Detail of the part on the ruler guide.

Fig. 3: Sheet clamp.

4.5 Running a Piece

Turn on the saw and unlock the table, slowly push it until the workpiece meets the saw blades.

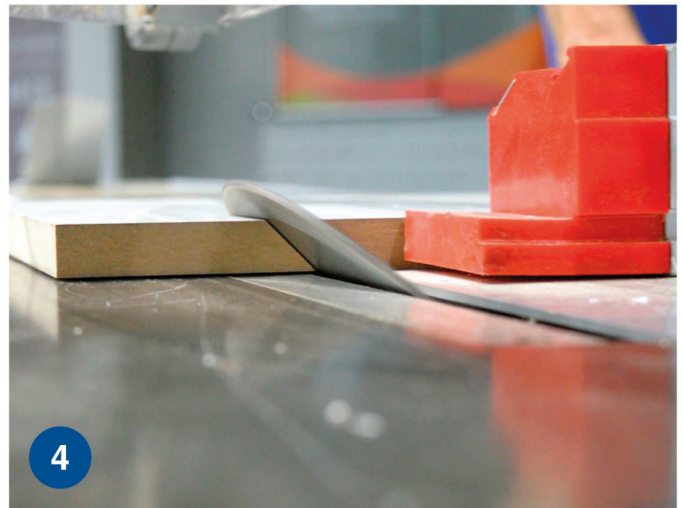
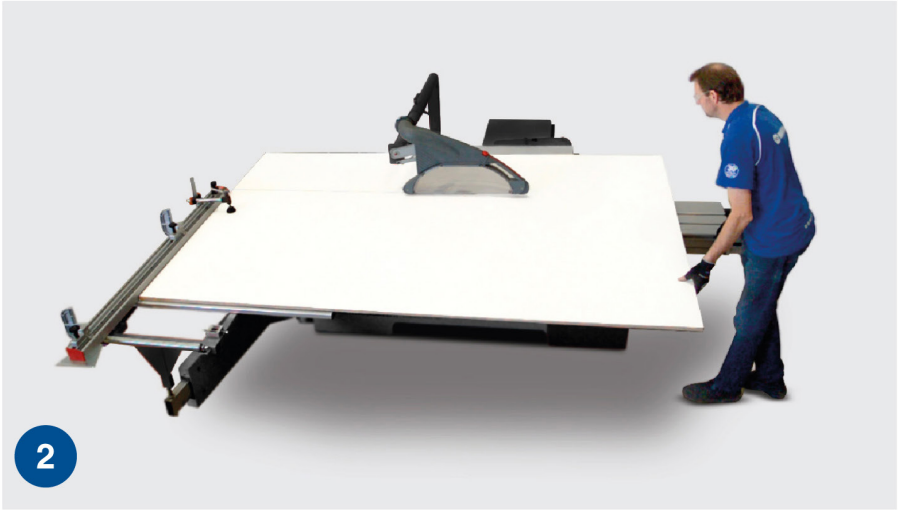
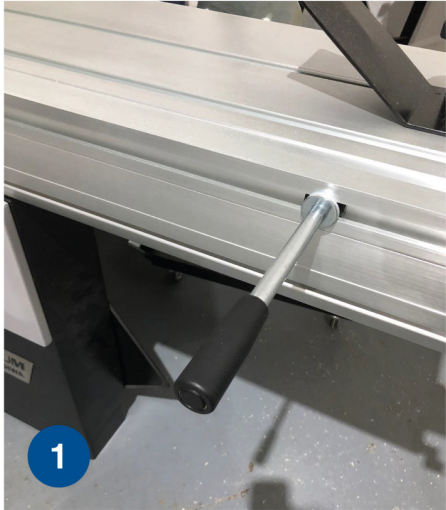

Fig. 1: Unlocking of the movable table.

Fig. 2: BMT.3200.IR Titanium cuts entire MDF sheets.

Fig. 3: Straight cut.

Fig. 4: Cutting at 45 degrees.

4.6 Cross Cutting

- Multi-piece cutting is not recommended, but can be done safely by making sure that each workpiece is securely attached to the table or the guide. A cross-section is made cutting the wood in the opposite direction to the fibers at any angle. A straight cross-section is done with the blade at 0°. Put the adjustable angle guide at zero, hold the wood firmly on the table against the guide. Turn on the saw. When the saw starts to gain speed (after approximately 1 second), move the piece gently through to cut the wood.
- Transverse cuts are made with the adjustable angle guide attachment at any angle other than 0°. This angle is often 45° to make corners but can be adjusted from 0° to 45°. After the desired angle is selected, be sure to tighten adjustable angle guide.

4.7 Cutting Frames, Boxes and Other Four-Sided Pieces

- To better understand how to cut these items listed below, we suggest you do simple projects using smaller piece until you develop enough experience with your saw.

Number of sides	Angle of bevel or Square
4	45°
5	36°
6	30°
7	25,7°
8	22,5°
9	20°
10	18°

- Adjusting the bracket to bevel the ends of two boards at an angle of 45° each produces a 90° angle. For this joint the arm of the bracket should be locked at 45°. The wood should be positioned having the flat on the table and the thin side against the guide.
- The following table provides the proper angles for a variety of shapes. The table assumes that all sides have the same length. For a format that is not in the table, use the following formula: 180° divided by the number of sides, is equal to the angle of the bevel or square.

4.8 Bevel Cuts

- A bevel cut is a cross section made with the cutting blade not perpendicular to the wood. To adjust the bevel, move adjustable angle guide and move the adjusting blade height as desired. Once the notch is at a desired angle lock the handle firmly.
- Beveled angles can be adjusted up to 45° to the left.

4.9 Support for Long Parts

- Turn off and unplug the saw. ALWAYS SUPPORT FRAGILE PIECES. Support long pieces using any convenient supports such as trestles or similar structures to prevent damage.
- SEE THE MAKSIWA CATALOG AND FIND PRODUCTS FOR THIS FUNCTION.

4.10 How to Adjust the Rip Fence

1. Thread 4pcs M12-1.75 x 115 studs into round rail.
2. Thread an M12-1.75 hex nut onto each stud and tighten the nuts against the round rail.
3. Thread an M12-1.75 hex nut and a flat washer half way onto each stud.
4. Insert the studs into the table. Tighten with an M12-1.75 hex nut, lock washer and a flat washer on each stud.
5. Slide the rip fence body onto the rail, then place the adjustable ring on the sliding table end of the rail and secure the ring with the set screw.
6. Thread the lock handles into the rip fence body and loosely install the fine adjustment knob. Place the end washer on the end of the rip fence rail and secure it with the M8-1.25 cap screw and lock washer.
7. Slide the alum. Rip fence onto the clamping plate and lock it with the handle on the top of the rip fence body.
8. Adjust the nuts on the outside of the table until the edge of the rip fence is parallel with the sliding table, aligning the fence with the edge of the sliding table.

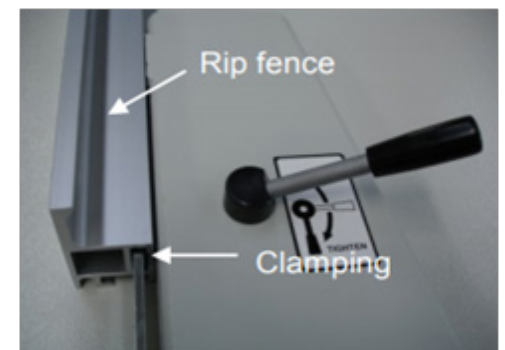

9. Check the height of the rip fence rail by sliding the rip fence along the rail and comparing the gap between the fence body and the table.
10. Adjust the height of the rip fence rail, then tighten all of the nuts against the table showed.
11. Check if the bottom of the rip fence rests on the surface of the table. If the rip fence does not rest on the table, then the fence is correctly adjusted, otherwise, loose the set screw and rotate the hex bolt to raise the roller, tighten the set screw to lock the ride height.

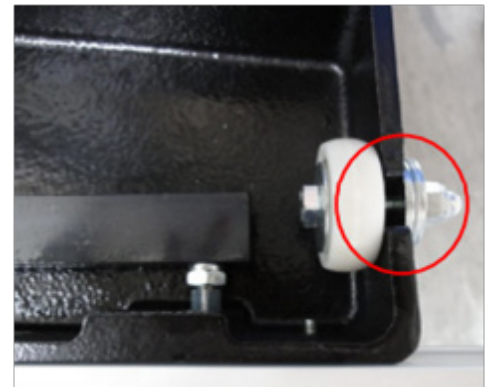
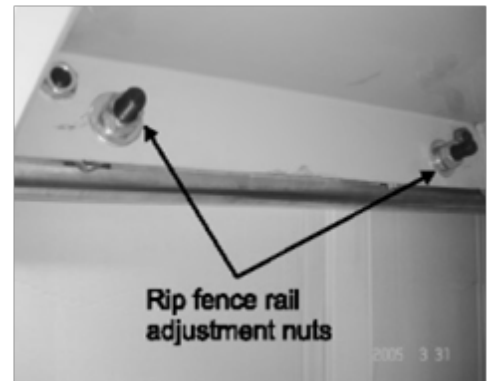

4.11 Main Blade

This saw is designed with 12" main saw blade, before you change blade sizes, the riving knife must be adjusted to match the size of blade you install.

1. Open the motor compartment and remove the foam shipping block and the red shipping brackets from the motors.
2. Move the blade tilt to 0° and raise the main blade as far as it will go.
3. Slide the table all the way forward to access the blade arbor and pull open the blade guard.
4. Use the arbor wrench to remove the arbor nut and arbor flange. **(The arbor nut has left hand threads and loosens by turning clockwise).** * Fix the saw blade by T Tool.



4.12 Fence Scale Alignment

Before operation, the 0" mark on the rip fence scale must be aligned with the right side of the blade to ensure that the rip fence measurements will be accurate.

1. Move the blade tilt to 0° (blade 90° to table), and raise the main blade all the way up.
2. Move the rip fence against the main blade.
3. Loosen the cap screws securing the fence scale.
4. Slide the fence scale to line up the first mark on the scale with the left edge of the rip fence and tighten the cap screw.
5. Set the rip fence at 1/8", slide the adjustable right against the rip fence body, and lock the ring in place. This will prevent the fence from hitting the blade.

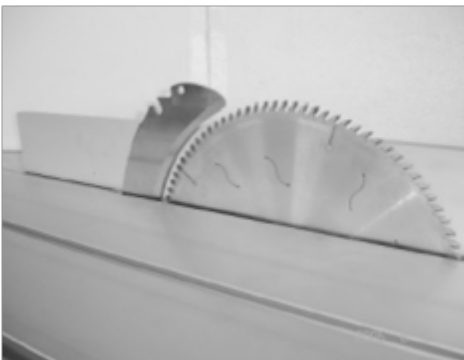

4.13 Riving Knife Adjustment

Whenever the blade is changed, then riving knife must be adjusted to 3mm away from the blade you install.

1. Disconnect the saw from power source
2. move the blade tilt to 0° (blade 90° to table) and raise the main blade as far as it will go.
3. Move the sliding table all the way forward to expose the internal blade guard that covers the blades and riving knife.
4. Pull the blade guard away from the riving knife to expose the mounting assembly.
5. Loose the riving knife center bolt, slide the riving knife away from the blade and slightly tighten.

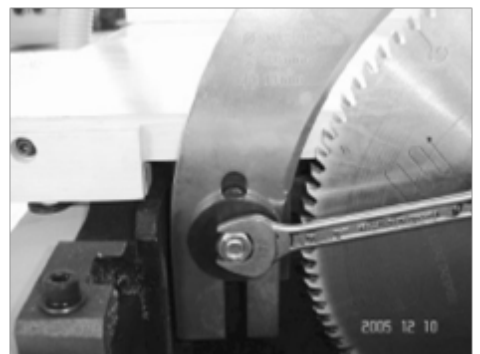

6. Position the riving knife about 3mm or 1/8" away from the nearest carbide tooth on the main blade.
7. Tighten the center bolt to secure the riving knife in position.
8. Move the blade guard back to its original position, and move the sliding table to center.

4.14 Changing Scoring Blade

1. Disconnect the saw from the power source.
2. Move the blade tilt to 0° (blade 90° to table), and raise the scoring blade all the way up.
3. Move the sliding table all the way forward to expose the internal blade guard that covers the blade and riving knife.
4. To hold the scoring use the U Tool and using the arbor wrench to remove the nut. (The arbor nut has right hand threads and loosens by turning counterclockwise).
5. Measure the main blade, and use the shims to stack the scoring blade set so the thickness matches the thickness of the main blade. (Only applicable if you use dado blades)
6. Install the blade set, re-install the arbor flange and the arbor nut, and tighten them against the blade set.
7. Move the orange blade guard back into its original position, next to the blades, and center the sliding table.
8. Align the scoring blade set to the main blade.

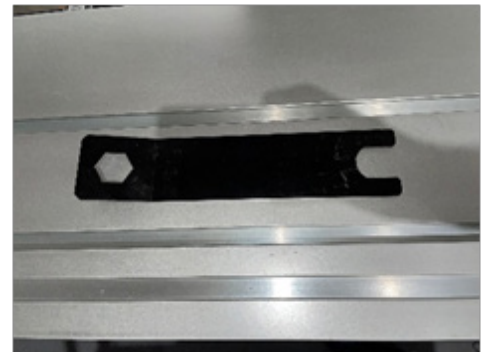

4.15 Rip Cutting

The panel saw has the capability of rip cutting full size panel panels, the sliding table removes the burden of sliding a large and heavy panel over a stationary table surface.

The saw also with the capability of rip cutting smaller boards which is using the machine as a traditional table saw. Smaller, lighter boards are easier to slide across the stationary cast iron table surface to the right of the saw blade.

Rip Cutting with The Sliding Table:

1. Install the crosscut fence in the center stud hole.
Note: Drop the crosscut fence into the center stud hole and align it to the 90° stop. Check to make sure the fence is at 90° and adjust it.
2. Slide the protection block to the edge of the slider, then tighten the lock knob. Scale will not be accurate if the protection block is cut.
3. Set a lip stop to the desired width-of-cut.
4. Position the blade guard to the correct height for your workpiece.
5. Load the workpiece onto the table saw.
6. Take all the necessary safety precautions, then perform the cutting operation.

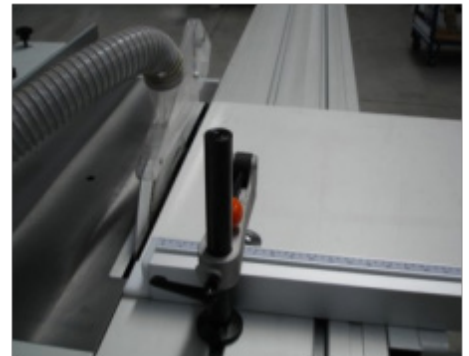
**4.16 Lubrication**

Lubricate the areas indicated below every 6-12 months, depending on frequency of use.

1. Blade angling trunnion.
2. Sliding table track.
3. Scoring blade threaded rod.
4. Blade height linkage.
5. Blade height bearing.
6. Blade tilt threaded rod.
7. Blade height slide.



4.17 Replace Belts

To change V-belt for the main motor.

1. Disconnect the saw from the power source.
2. Move the blade tilt to 0° (blade 90° to table) and raise the main blade and scoring blade set up.
3. Open the motor cabinet door.
4. Loosen the hex head bolt A and B, and tight the hex head bolt B.
5. Remove the V-belt and replace them with new belts. Then loosen the hex head bolt B. (Pivot the motor down)
6. Tighten the hex head bolt A and B until the belts deflect between a 1/4" and a 1/2" when pressed firmly in the center of each V-belt.
7. Close and secure the motor cabinet door.

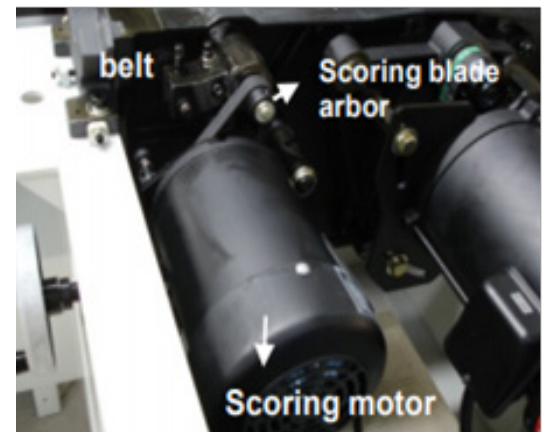

To change flat belt for the scoring motor (Option):

1. Disconnect the saw from the power source.
2. Move the blade tilt to 0° (blade 90° to table) and raise the main blade and scoring blade set up.
3. Open the motor cabinet door.
4. Push the scoring blade motor and remove the flat belt.
5. Place the flat belt on the scoring blade arbor, lift the scoring motor and slide the flat belt over the scoring motor pulley.
6. Close and secure the motor cabinet door.

5 Maintenance

Make sure that your machine is disconnected from the power source before performing any maintenance, cleaning, lubrication, adjustments or changing accessories, blades, etc.

5.1 General Cleanliness

- Please DO NOT attempt to remove the wood chips while the saw is turned on.
- Clean all saw dust and periodically remove lumps of wood even if you use a dust collector, there may be parts that remain in the machine.
- After each work cycle, clean all parts, vacuum the chips, dust and any resin.
- Periodically use compressed air to blow electrical contacts and moving mechanical parts due to the accumulation of dust in the saw.
- Use a vacuum cleaner to clean inside the motor case.
- Apply oil (SAE10) or equivalent lubricant to the moving parts only after equipment has been completely cleaned.
- Weekly clean and lubricate the moving parts of the machine with a thin film of oil and grease.
- Protect all belts and pulleys from contamination with oil.
- Always use a dust collector with a minimum of 2 HP.

5.2 Electrical Maintenance

- Apply a multi-purpose or electrical cleaner to the electrical components periodically (on average every 3 months).
- We recommend that you use a surge protection circuit breaker, installed in the power supply workshop to prevent short circuits of any electrical component of the machine.

5.3 Mechanical Maintenance

- Maintain tension on the belts, if you notice any changes in the way the saw blade spins.
- If you need to replace the lubricating oil in the tank, use the SAE-10.
- Lubricate by pumping handle on oil tank once before major work.
- Parts used are durable, they should not break easily and should last for several years.
- Check for bolts or nuts that need to be retightened.
- Always replace broken parts with OEM spare parts.
- Only use blades that are sharpened correctly, according to EN 847 1: 2005 used. Do not use blades that have a maximum speed less than, the maximum speed of the saw's motors. Always leave a space between the riving knife and the saw blade of at minimum 3 mm (1/8 in) and at most 8 mm (3/8 in).

5.4 Saw Blade Lubrication Chart

		Machine		Saw					
		Model		BMS.3200.IR					
Table of grease and lubrican		Where to apply?		Sliding table track	Height adjustment guide	Threaded rod	Handle base	Tilt system	
		Grease/Oil suggested	MOBIL	-	MOBILUX EP2	MOBILGREASE HP 222 MOBILGREASE MP			
			ESSO	-	LITHTAN EP2	BEACON 2			
			SHELL	-	EPRO	ALVANIA R2			
			CASTROL	-	SPHEEROL EP2	LM 2			
			BARDAHL	-	-	MAX LUB APG2			
			IPIRANGA	-	-	IPIFLEX 2			
			PETROBRAS	-	-	GMA-2			
			TEXACO	-	-	MARFAK MP2			
			CARBOGRAFITE	-	Silicone	-			
Lubrication period		40 hours							

5.5 Part Replacement and Disposal

- If replacement should become necessary, only OEM parts should be used to ensure the same efficiency. The parts should be discarded according to the laws of each country. The substitutions of parts require training and technical skills; for this reason, the following instructions should be followed by qualified personnel to prevent damage to the machine and risks to the safety of people.
- CAUTION: In the event of mechanical or functional defects in the machine, including tools, please contact your service representative for service. Any repairs must be made only when the machine is disconnected from any power supply.

6 Troubleshooting Guide

- The necessary interventions should be made by our technical specialists. For any maintenance or repairs, please turn off the machine, remove the machine from the power supply and wait until the blade stop completely and then proceed with the service.
- For any problem, information or abnormality with the machine, contact the distributor in your area or directly with our service center after sale of MAKSIWA INTERNATIONAL INC., through 844-319-6594

Problem	Possible Cause	Solution
Saw stopped, no longer spins.	Excessive load on the motor.	Wait for motor to cool off, then flip off/on circuit breaker.
	Saw has fallen off of shaft.	Check washer and lock nut.
	Triggered circuit breaker.	Flip circuit breaker off/on.
	Damaged or loose wire.	Locate and replace wire.
Does not make exact cuts at 45° or 90°.	Misaligned blade stopper.	Adjust the stop.
	Wood is warped.	Replace wood for a good piece.
	Loose blade nut/ Warped saw blade.	Tighten nut or replace Blade.
	Riving knife not aligned.	Riving knife with the saw blade.
Saw makes unsatisfactory cuts.	Worn Blade.	Sharpen or replace blade.
	Mounted in the wrong direction.	Flip the blade.
	Glue on the blade.	Remove and clean blade.
	Worn blade for the material being cut.	Use correct blade.
	Glue on the table.	Clean the table.
Blade does not keep constant speed.	Incorrect wire gauge/size.	Use correct gauge/size wire.
	Low voltage.	Call electric service provider.
	Motor wiring is setup is incorrect.	Check and adjust wiring in motor.
Saw blade vibrates	Machine is not level.	Put the machine at level.
	Blade is damage.	Replace blades.
	Damage belt.	Replace belt.
	Pulled is tilted.	Replace pulley.
	Motor was assembled in the wrong position	Verify and adjust the motor.
	Hight guide is loose.	Tighten or adjust guide.
Wood kicks back when it comes in contact with the blade.	Aluminum guide is misaligned.	Align the guide.
	Riving knife misaligned.	Align the riving knife.
	Cut was made without guide support.	Install and use the guide.
	Worn blade.	Replace the blade.
	Piece was not held correctly.	Hold piece all the way through.
Blade has no height adjustment and slope.	The elevation system is too tight.	Adjust the elevation system.
	Dust and chips of wood are in the elevation system.	Clean and lube the components.

7 Exploded View

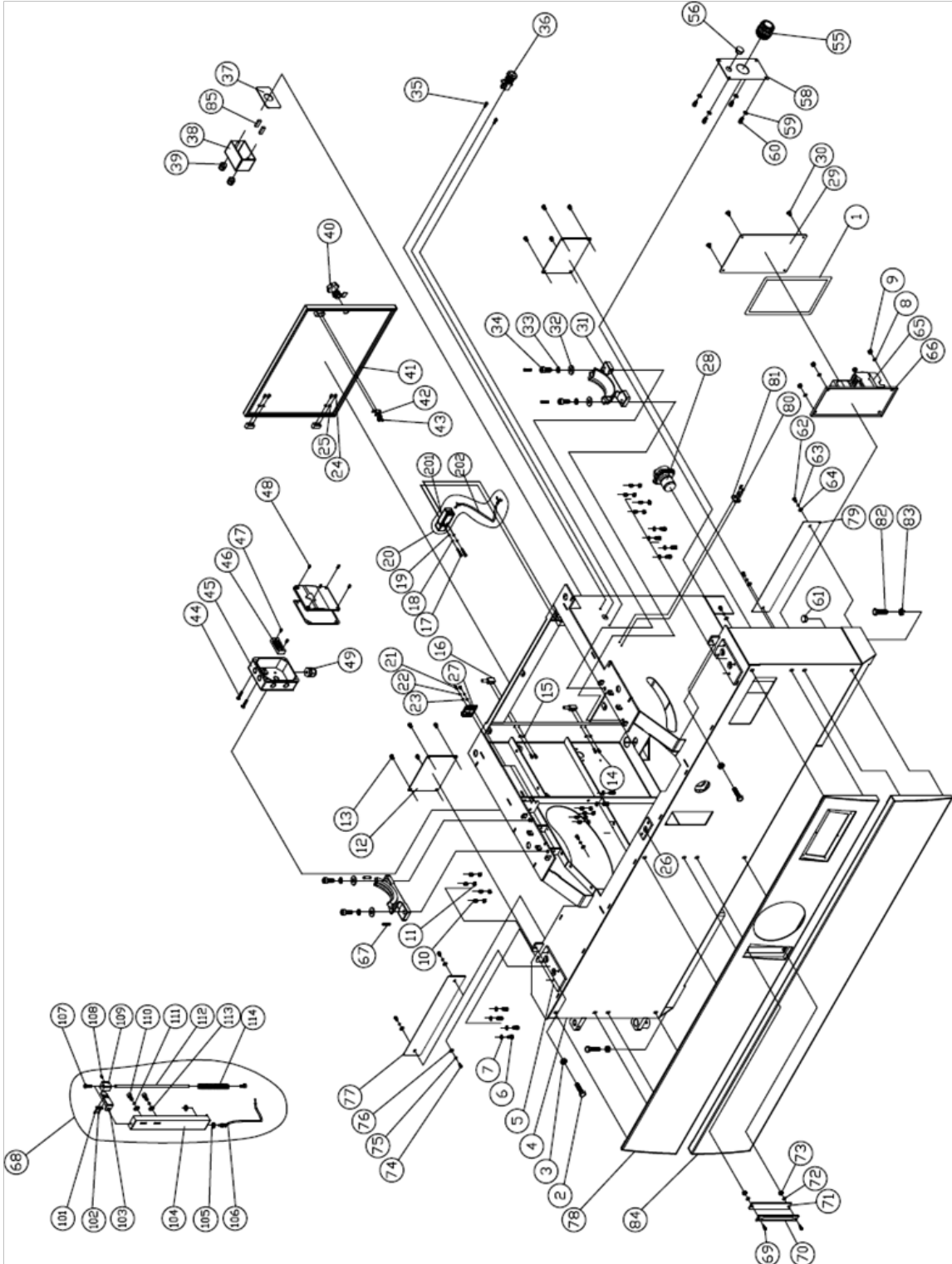

Item	Part N°	Parts Name	Size	Qty	Note
1	150527	Pad	2x300x7.5(M/M)	4	
2	SH100800	Hex Head Bolt	M10*40	2	
3	NH101700	Hex Nut	M10	2	
4	206477	Machine frame		1	T9
5	205200-37	Plate		2	R
6	SR069300	Cap Screw	M6*12	10	
7	WS060000	Lock Washer	M6	10	
8	WF061310	Washer	M6x13	4	
9	NF061000	Hex Flange Nut	M6	4	
10	SS060400	Set Screw	M6*20	12	
11	NH061000	Hex Nut	M6	12	
12	207128	Plate		3	T9
13	SJ069300	Button Head Screw	M6*12	12	
14	SR059300	Cap Screw	M5*12	4	
15	WS050000	Lock Washer	M5	4	
16	203412	Block		2	
17	SR040600	Cap Screw	M4*30	2	
18	WS040000	Lock Washer	M4	2	
19	WF040808	Washer	M4*8	2	
20	AB136458	Door Safety Switch ASM		1	
21	SR069300	Cap Screw	M6*12	2	
22	WS060000	Lock Washer	M6	2	
23	WF061310	Washer	M6x13	2	
24	SR059200	Cap Screw	M5*8	4	
25	WS050000	Lock Washer	M5	4	
26	205200-28	Plate		1	T9
27	206342	Plate		1	
28	994809	Power Switch	ZH-HD-2	1	
29	201893	Plate		1	T9
30	SJ060200	Button Head Screw	M6x10	4	
31	207540	Base		2	X2
32	WF102030	Washer	M10*20	4	
33	WS100000	Lock Washer	M10	4	
34	SR100700	Cap Screw	M10*35	4	
35	ST050400	Tap Screw	M5*20	2	
36	994808	Emergency Stop Button	R2PNR4-1B-R	1	

Item	Part N°	Parts Name	Size	Qty	Note
37	150956	Pad		1	
38	605408	Switch Box		1	
39	998621	Strain Relief		2	
40	203430	Lock		1	
41	205259	Door		1	R
42	WS040000	Lock Washer	M4	2	
43	SPO40400	Pan Head Screw	M4*20	2	
44	SJ060400	Button Head Screw	M6*20	2	
45	201105	Power Box	CE	1	CE
	201105A	Power Box		1	CSA
46	994805	Terminal	PB2504 4P	0	CE
	994805	Terminal	PB2504 4P	1	CSA
47	SPO59200	Pan Head Screw	M5*8	2	
48	SJ059300	Button Head Screw	M5*12	4	
49	709421	Strain Relief	PG20	2	
55	207318	Strain Relief	MGB40-25B	1	
56	201458	Hole Plugs	HP-22	1	
58	207080	Plate		1	
59	WS060000	Lock Washer	M6	4	
60	SR069300	Cap Screw	M6*12	4	
61	201458	Hole Plugs	HP-22	1	
62	SJ069300	Button Head Screw	M6*12	4	
63	WS060000	Lock Washer	M6	4	
64	WF061310	Washer	M6*13	4	
65	200867	Electric. Panel	400V 3~	1	
66	200867A-1	Plate		1	
67	PS062500	Spring Pin	6*25	4	
68	AB207399	Steel Wire ASM		1	
69	SPO40400	Pan Head Screw/W	M4x20	2	
70	LM001076	Tilt Scale		1	
71	201785	Plate		1	
72	WF040808	Washer	M4*8	2	
73	NF040700	Hex Nut	M4	2	
74	SR069300	Cap Screw	M6*12	12	
75	WS060000	Lock Washer	M6	12	
76	WF061310	Washer	M6*13	12	
77	207309-33	Plate		1	T9

Item	Part N°	Parts Name	Size	Qty	Note
78	206580	Front Cover		1	R
79	207299-32	Plate		1	T9
80	ST049300	Tap Screw		2	
81	170736	Hanger		1	
82	SH161000	Hex Head Bolt	M16*50	4	
83	NH162400	Hex Nut	M16	4	
84	206478	Front Cover		1	T9
85	136019	Cord Connector	224-201	2	
89	WF061310	Washer	M6*13	8	
90	206367-33	Cap Screw		1	
91	206368	Front Cover		1	
92	206367-32	Cap Screw		1	
93	ST049300	Tap Screw		4	
94	170736	Hanger		2	
95	SP059400	Pan Head Screw	M5x16	2	
96	SH120800	Hex Head Bolt	M12*40	4	
97	NH121900	Hex Nut	M12	4	
101	WF051210	Washer	M5x12	2	
102	SP050200	Pan Head Screw	M5x10	2	
103	200840	Pointer		1	
104	200841	Fix Plate		1	
105	WF061310	Washer	M6x13	2	
106	207399	Steel Wire		1	
107	SR050200	Cap Screw	M5x10	2	
108	SS050200	Setscrew	M5x10	1	
109	200843	Indicator Block		1	
110	SR069300	Cap Screw	M6x12	2	
111	WS060000	Lock Washer	M6	2	
112	200842	Shaft		1	
113	WF061310	Washer	M6x13	2	
114	200993	Spring		1	

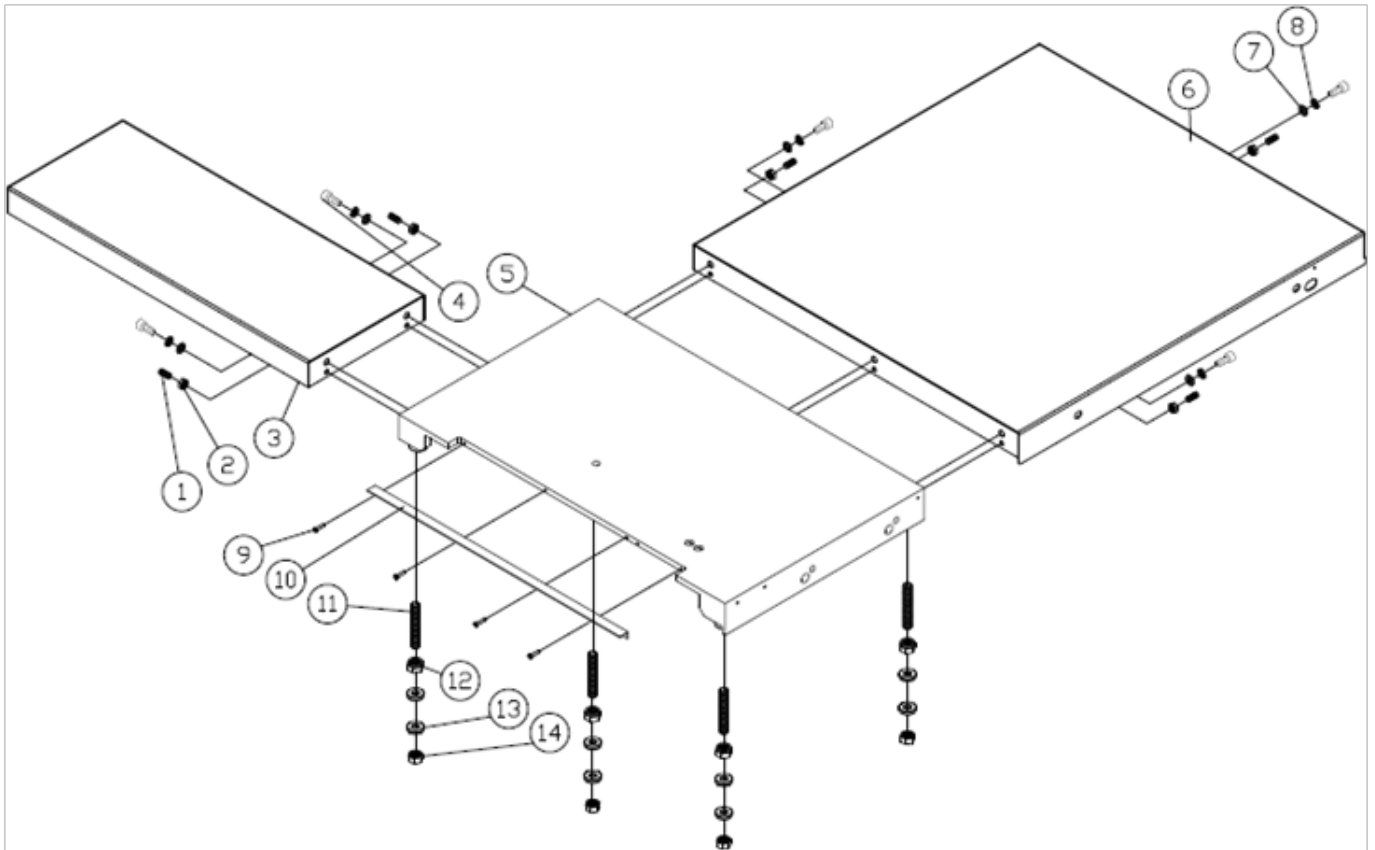

Item	Part N°	Parts Name	Size	Qty	Note
1	SS100400	Set Screw	M10*20	5	H
2	NH101700	Hex Nut	M10	5	H
3	207077	Left Ext. Plate	(standard)	1	R
	207151	Left Ext. Plate	(optional)	1	R / S
4	SR100500	Cap Screw	M10*25	5	H
5	206332	Table		1	R
6	207078	Ext. Plate	(standard)	1	R
	207079	Ext. Plate	(optional)	1	R / S
7	WF102030	Washer	M10* \varnothing 20	5	H
8	WS100000	Lock Washer	M10	5	H
9	SJ069300	Button Head Screw	M6*12	4	
10	206354	Table Insert		1	
11	SS162000	Set Screw	M16*100	4	
12	NL162400	Lock Nut	M16	4	
13	205016	Washer		8	
14	NH162400	Hex Nut	M16	4	

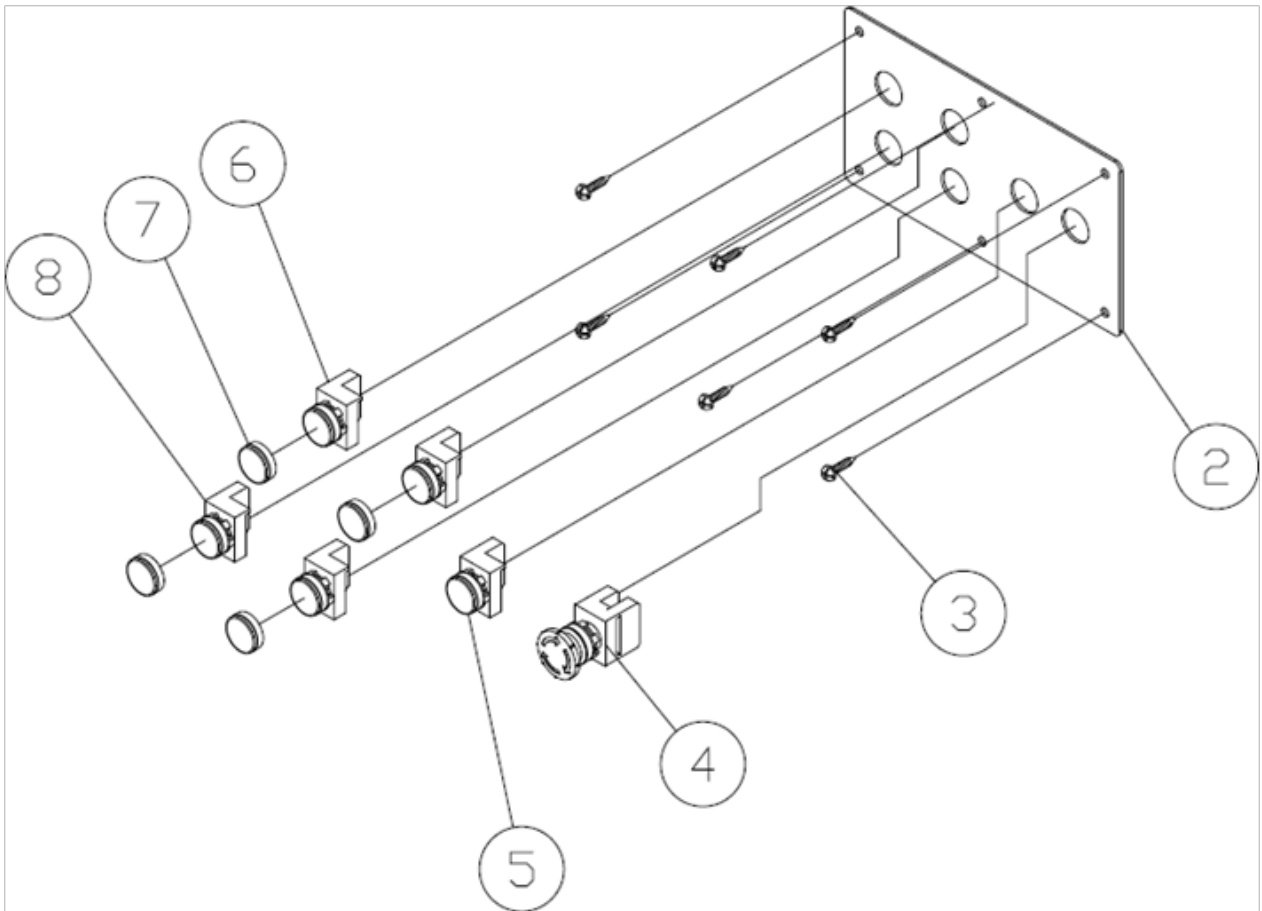

Item	Part N°	Parts Name	Size	Qty	Note
2	206407	Panel		1	
3	SJ050200	Button Head Screw	M5*10	6	
4	994808	Emergency Stop Button		1	
5	996002	Pilot Lamp	YK.24V 22 (W)	1	
6	994855	Switch Button-ON	R2 PNF-1A-G	2	
7	994855A	Dust Cove	R2 PRCF	4	
8	994856	Switch Button-OFF	R2 PNF-1B-R	2	

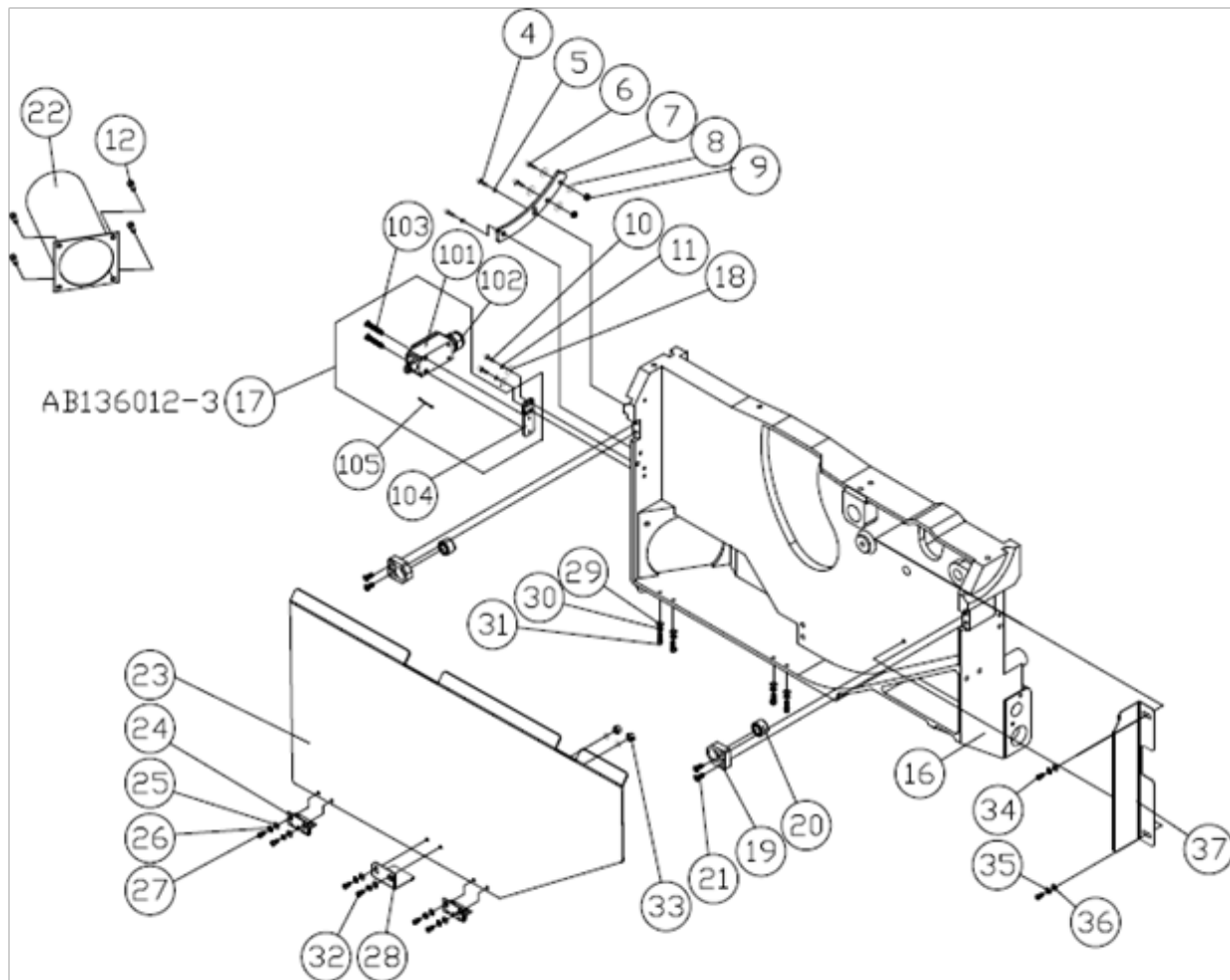

Item	Part N°	Parts Name	Size	Qty	Note
4	SR069300	Cap Screw	M6*12	2	
5	WS060000	Lock Washer	M6	2	
6	SR059400	Cap Screw	M5*16	2	
7	206337	Fix Plate		1	
8	WF051010	Washer	M5*10	4	
9	NL050800	Lock Nut	M5	2	
10	SR059300	Cap Screw	M5*12	2	
11	WS050000	Lock Washer	M5	2	
12	SF089300	Hex Head Bolt (+)/W	M8x12	4	
16	206301	Channel Base		1	YF206301
17	AB136012-3	Door Safety Switch Assembly		1	A
18	WF051010	Washer	M5*10	2	
19	206359	Plate		2	

Item	Part N°	Parts Name	Size	Qty	Note
20	203249	Magnetic Iron(assembly)		2	A
	203249-1	Magnetic Iron		1	
	203249-3	Screw		1	
21	SM060400	Sunk head Socket Screw	M6x20	4	
22	206118	Dust Port		1	
23	206324	Cover		1	F1L
24	207940	Hinge		2	
25	WF051010	Washer	M5*10	8	
26	WS050000	Lock Washer	M5	6	
27	SR059200	Cap Screw	M5*8	4	
28	207152	Plate		1	
29	WF051010	Washer	M5*10	4	
30	WS050000	Lock Washer	M5	4	
31	SR050200	Cap Screw	M5*10	4	
32	SR059400	Cap Screw	M5*16	2	
33	NH050800	Hex Nut	M5	2	
34	SR060200	Cap Screw	M6*10	2	
35	WS060000	Lock Washer	M6	2	
36	WF061620	Washer	M6*16	2	
37	206479	Plate		1	

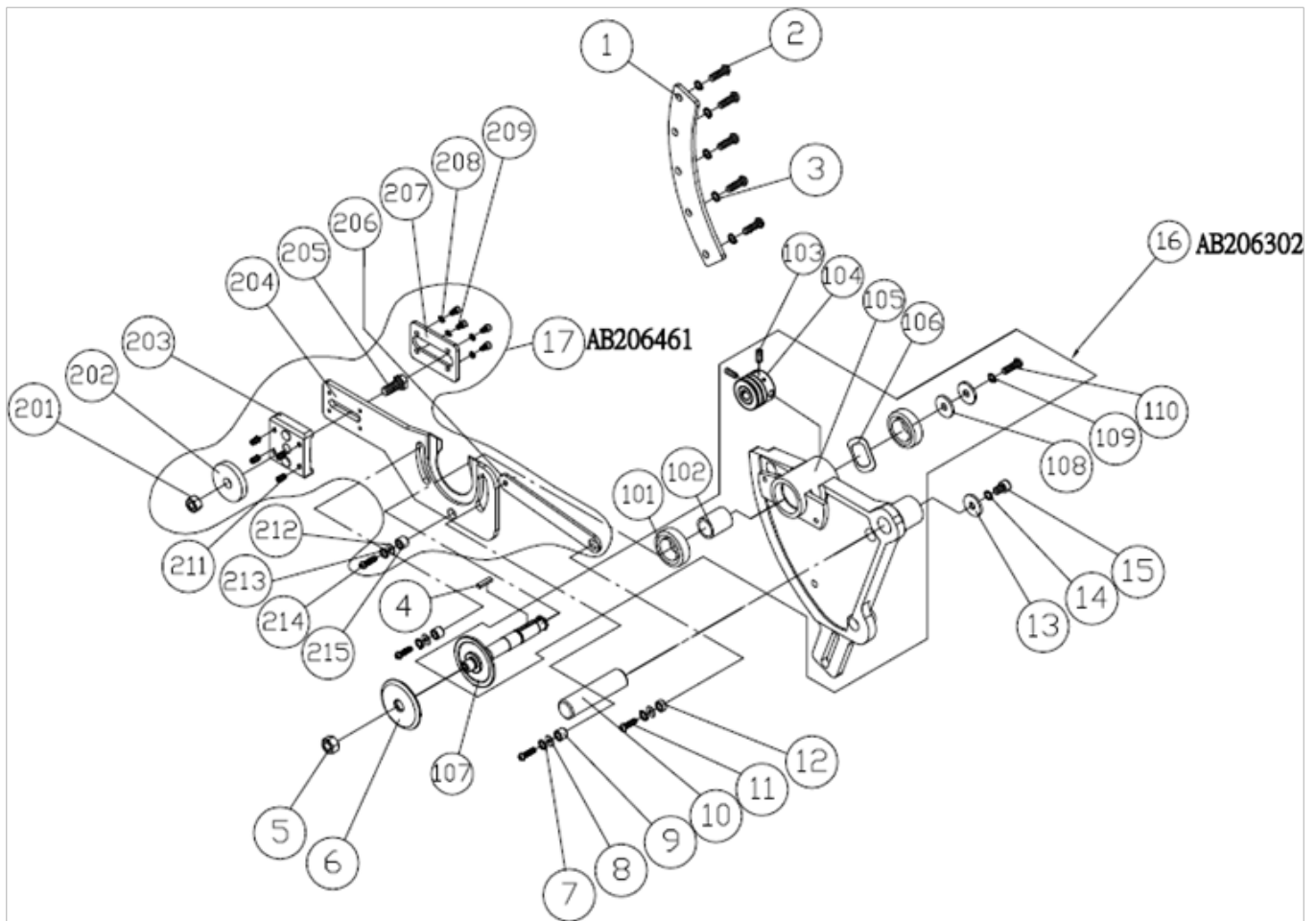

Item	Part N°	Parts Name	Size	Qty	Note
1	206304	Gip Plate		1	
2	SJ100500	Button Head Screw	M10×25	5	
3	WS100000	Spring Washer	M10	5	
4	KD050520	Key	5x5x20	1	
5	201822	Nut	M16x2.0	1	
6	206350	Arbor Flange	25.4	1	S
	206380	Arbor Flange	30	1	
7	WS080000	Lock Washer	M8	3	
8	WF083030	Washer	M8×30	3	
9	200964	Bushing		3	
10	201205	Shaft		1	
11	SJ080400	Button Head Screw	M8×20	3	

Item	Part N°	Parts Name	Size	Qty	Note
12	201346	Bushing		1	
13	WF083030	Washer	M8×30	1	
14	WS080000	Lock Washer	M8	1	
15	SR080400	Cap Screw	M8×20	1	
16	AB206302-4	Main arbor (30 , Pulley 60HZ)	SS-D30P2 D305P2	1	A
17	AB206461	Fix Block ASM		1	
101	BB620604	Bearing	6206LLB	2	
102	206311	Spacer		1	
103	SS050200	Setscrew	M5×10	3	
104	208041	Pulley		1	
105	206302	Rotate Plate		1	YF206302
106	WW476004	Wave Washer	47×60	2	
107	206357	Main Arbor	30	1	
	206310	Main Arbor	25.4	1	S
108	WF083030	Washer	M8×30	2	
109	WS080000	Lock Washer	M8	1	
110	SJ080400	Button Head Screw	M8×20	1	
201	NH101704	Hex Nut	M10	1	
202	WF104040	Washer	M10×40	1	
203	206461	Fix Block		1	
204	206309	Locate Plate		1	
205	SH100600	Hex Head Bolt	M10×30	1	
206	206360	Link Plate		1	
207	201881	plate		1	
208	WS050000	Lock Washer	M5	4	
209	SJ050200	Button Head Screw	M5×10	4	
211	SS050200	Setscrew	M5×10	4	
212	WF083030	Washer	M8×30	1	
213	WS080000	Lock Washer	M8	1	
214	SJ080400	Button Head Screw	M8×20	1	
215	200964	Bushing		1	

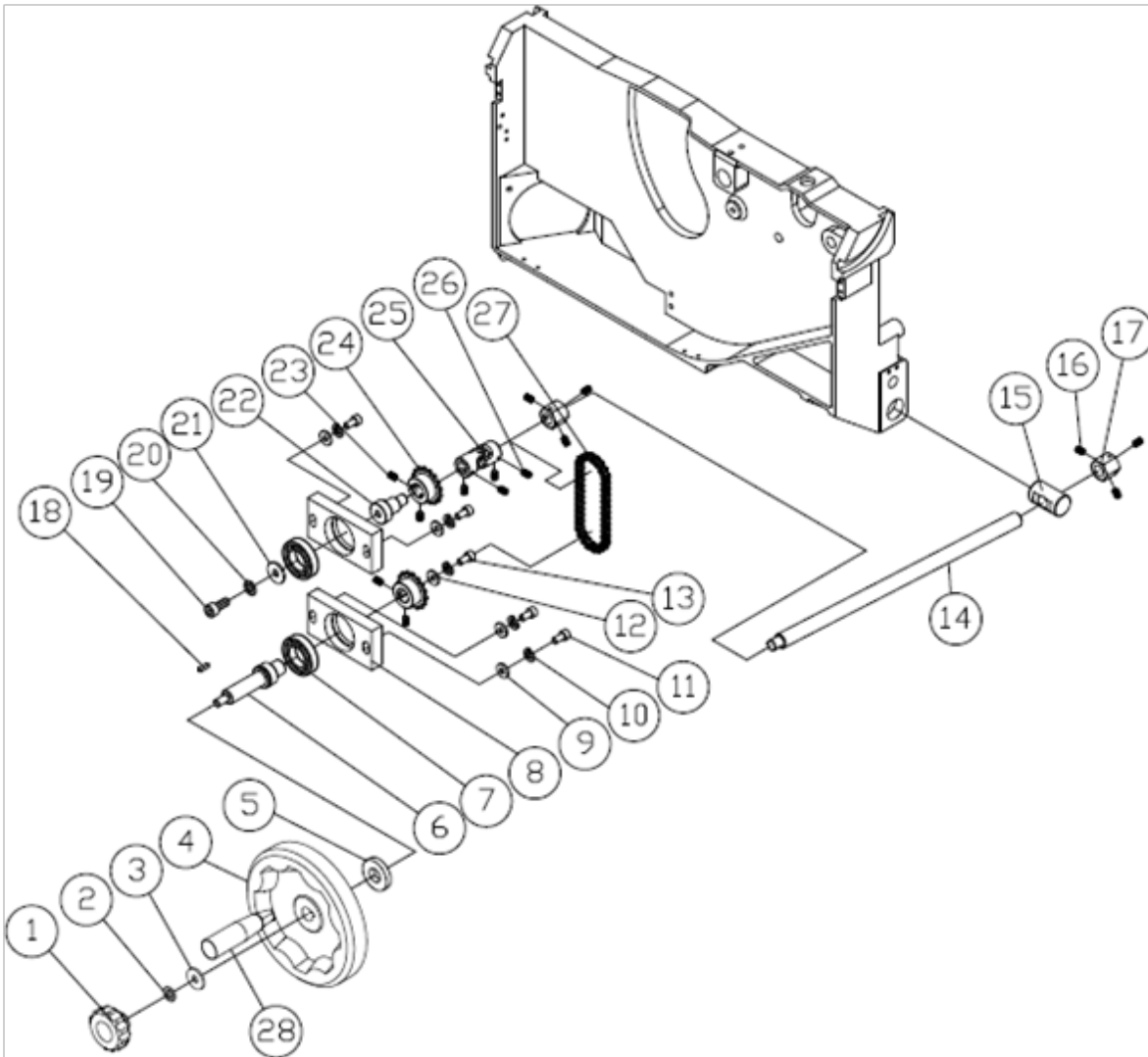

Item	Part N°	Parts Name	Size	Qty	Note
1	100203	Lock Knob	M10	1	
2	204263	Washer	10×20	1	
3	WF102730	Washer	M10×27	1	
4	206434A	hand wheel	8"	1	
5	201567	Washer		1	
6	206444	Shaft		1	
7	BB600602A	Bearing	6006ZZ	2	
8	206409	Locate Plate		2	
9	WF081818	Lock Washer	M8x18	4	
10	WS080000	Lock Washer	M8	5	
11	SR080700	Cap Screw	M8×35	4	
12	WF083030	Lock Washer	M8x30	1	

Item	Part N°	Parts Name	Size	Qty	Note
13	SR080400	Cap Screw	M8×20	1	
14	207176	Screw		1	
15	206328	Shaft		1	
16	SS069100	Set Screw	M6×6	6	
17	206379	Set Nut		2	
18	KS070720	Key	7x7x20	1	
19	SR100400	Cap Screw	M10*20	1	
20	WS100000	Lock Washer	M10	1	
21	WF104030	Washer	M10×40	1	
22	206410	Shaft		1	
23	SS060200	Set Screw	M6×10	4	
24	207115	Sprocket		2	
25	207461	Free Joint	14	1	
26	SS069100	Set Screw	M6×6	4	
27	206441	Chain		1	
28	200866-1			1	

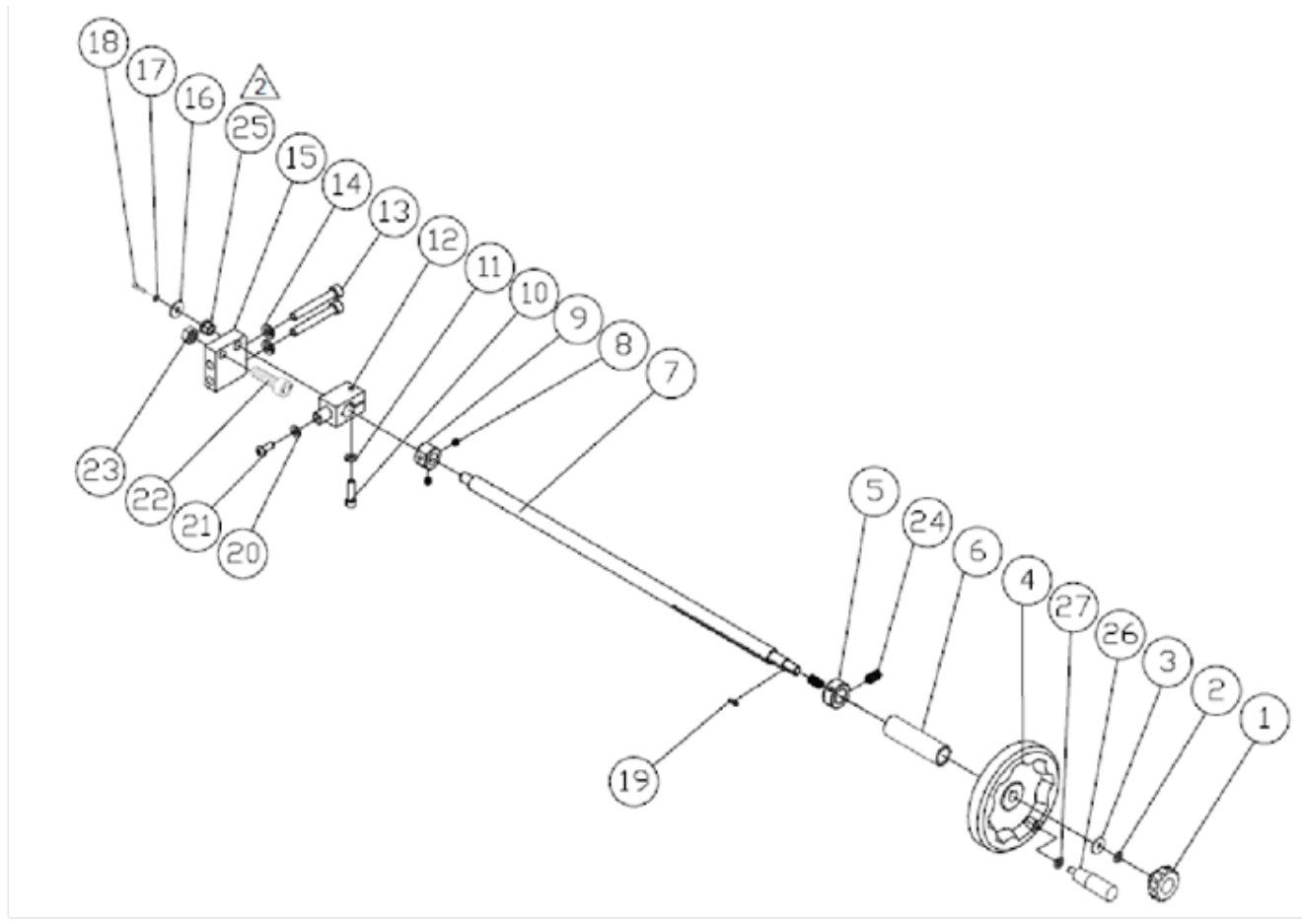

Item	Part N°	Parts Name	Size	Qty	Note
1	100203	Lock Knob	M10	1	
2	204263	Washer	10×20	1	
3	WF103030	Washer	M10×30	1	
4	204289B	Hand Wheel		1	standard
	204176A	Hand Wheel		1	S
5	200855	Bushing		1	
6	206385	Sleeve		1	
7	206327	Screw		1	
8	SS069100	Setscrew	M6×6	3	
9	206379	Set Nut		1	
10	SR060600	Cap Screw	M6×30	1	
11	WS060000	Lock Washer	M6	2	
12	206326	Hex Nut		1	
13	SR081200	Cap Screw	M8×60	2	

Item	Part N°	Parts Name	Size	Qty	Note
14	WS080000	Lock Washer	M8	2	
15	206325	Locate Block		1	
16	WF061310	Washer	M6×13	1	
17	WS060000	Lock Washer	M6	1	
18	SR069300	Cap Screw	M6×12	1	
19	KS050520	Key	5*5*20	1	
20	WF061620	Washer	M6×16	1	
21	SJ060200	Cap Screw	M6×10	1	
22	SS100700	Setscrew	M10×35	1	
23	NH101700	Hex Nut	M10	1	
24	SS080200	Setscrew	M8x10	2	
25	017177			1	
26	206460	Handle	M10 , 7"	1	standard
27	WF101608	Washer	M10×16×t0.8	1	

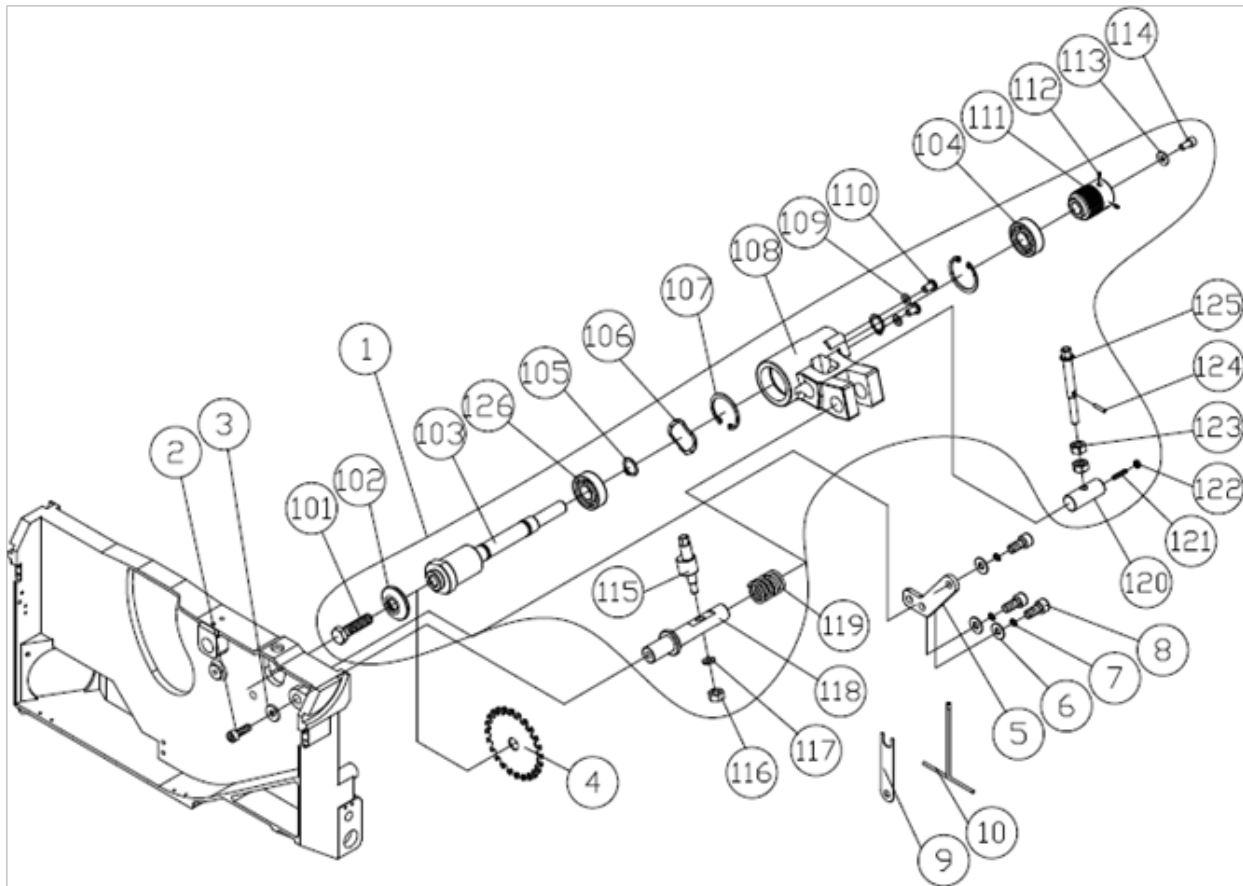

Item	Part N°	Parts Name	Size	Qty	Note
1	AB206315-1	Pulley ASM		1	
2	SR080400	Cap Screw	M8*20	1	
3	WF083030	Washer	M8*30	1	
4	200973	Scoring Saw Blade	20	1	
5	206365	Fix Plate		1	
6	WF061310	Washer	M6x13	3	
7	WS060000	Lock Washer	M6	3	
8	SR069400	Cap Screw	M6*16	3	
9	206366	Wrench		1	
10	206369	Wrench	8mm	1	
101	SH120440	Hex Head Bolt	M12x20	1	
102	206320	Flange		1	
103	206321	Shaft		1	
104	BB620204	Ball Bearing	6202LLB	1	
105	RS150000	Int. Retaining Ring	S15	2	

Item	Part N°	Parts Name	Size	Qty	Note
106	WW263403	Wave Washer	26*34 t=0.3 (6202)	2	
107	RR350000	Int. Retaining Ring	R35	2	
108	206303	Shaft		1	YF206303
109	WF061310	Washer	M6x13	2	
110	SJ069400	Button Head Screw	M6*16	2	
111	206315	Pulley		1	
112	SS069100	Set Screw	M6×6	3	
113	WF061620	Washer	M6x16	1	
114	SH069402	Hex Head Bolt	M6×16(L.H)	1	
115	206316	Shaft		1	
116	NL061000	Lock Nut	M6	1	
117	206395	Spring	15*6.2*0.5t	1	
118	206318	Shaft		1	
119	206323	Spring		1	
120	206319	Shaft		1	
121	206386	Set Screw	M6*25	1	
122	NH061000	Hex Nut	M6	1	
124	PS031200	Spring Pin	3*12	1	
125	206317	Screw		1	
126	BB600304	Ball Bearing	6003LLB	1	

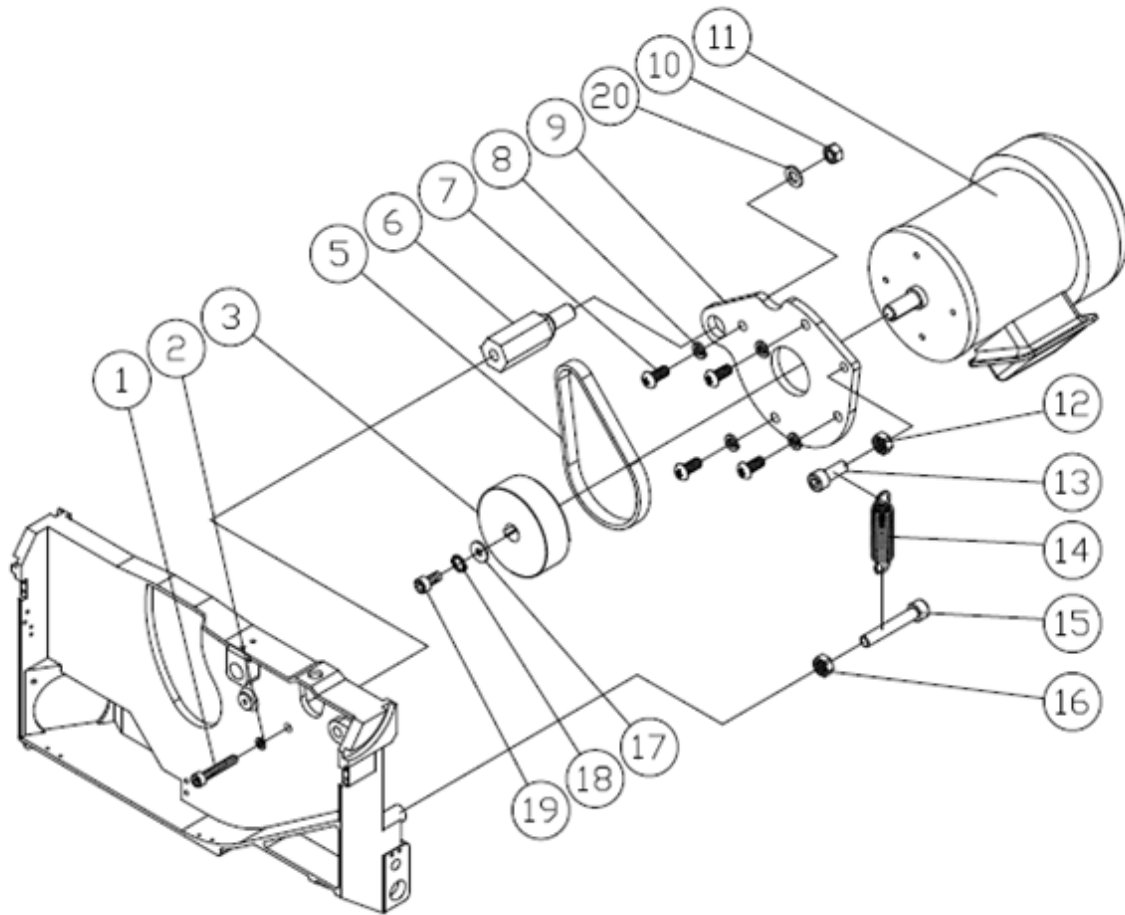

Item	Part N°	Parts Name	Size	Qty	Note
1	SR122000	Cap Screw	M12*100	1	
2	WS120000	Lock Washer	M12	1	
3	206314	Pully		1	50Hz
	206336	Pully		1	60Hz
5	LJ014070	Belt	140J7	1	60Hz
	LJ015070	Belt	150J7	1	50Hz
6	206313	Shaft		1	
7	SJ080400	Button Head Screw	M8*20	4	
8	WS080000	Lock Washer	M8	4	
9	206331	Plate		1	
10	NL142200	Lock Nut	M14	1	
11	MH206301	Scoring Motor	0.75P (M20P)	1	optional
12	NH101700	Hex Nut	M10	1	
13	SR100400	Cap Screw	M10*20	1	
14	201275	Expansion Spring		1	

Item	Part N°	Parts Name	Size	Qty	Note
15	SR101000	Cap Screw	M10*50	1	
16	NH101700	Hex Nut	M10	1	
17	WF063030	Washer	M6*30	1	
18	WS060000	Lock Washer	M6	1	
19	SR069400	Cap Screw	M6*16	1	
20	WF143530	Washer	M14*35	1	

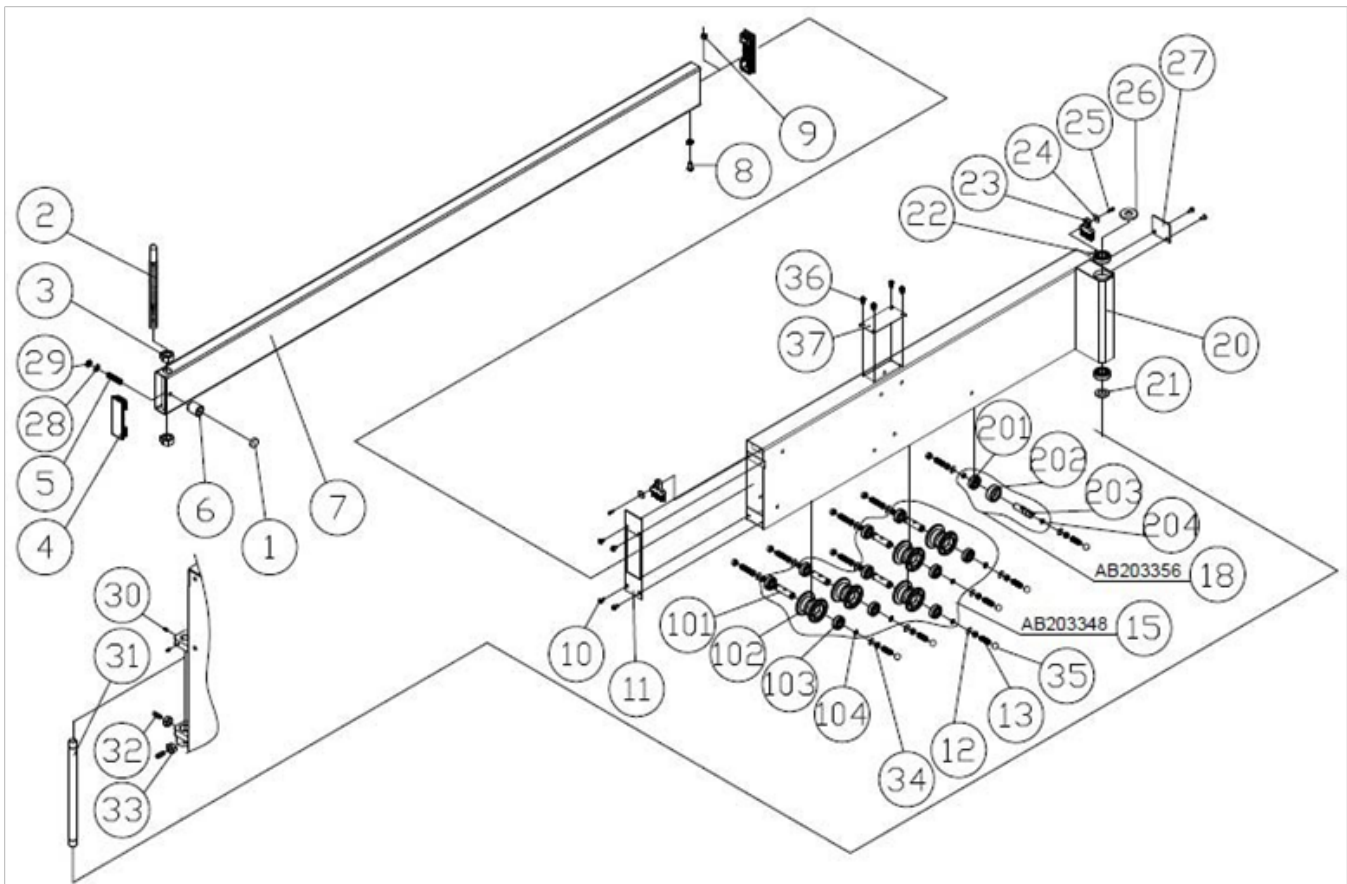

Item	Part N°	Parts Name	Size	Qty	Note
1	200934-2	Magnet		1	
2	203416	Screw Threads		1	S,E
	205505A	Screw Threads		1	S,D
3	NH203000	Hex Nut	M20x2.5p	2	
4	203470	Plug	40*120	2	
5	SS080700	Set Screw	M8*35	1	

Item	Part N°	Parts Name	Size	Qty	Note
6	201146-1	Magnetic Bracket		1	
7	207856	Sliding Tube		1	T
8	SH080400	Hex Head Screw	M8*20	1	
9	NH081300	Hex Nut	M8	2	
10	SJ060200	Button Head Screw	M6*10	6	
11	207085	Cover		1	VE
12	WF081818	Washer	M8*18	8	
13	SS080500	Setscrew	M8*25	8	
15	AB203348	Roller Assembly		5	
18	AB203356	Ring Assembly		1	
20	206421	Swing Arm		1	VE
21	WF203730	Washer	M20*37	1	
22	BB600402A	Bearing	6004ZZ	2	
23	135051-A	Brush		2	
24	WF061310	Washer	M6*13	2	
25	SR060400	Cap Screw	M6*20	2	
26	WF203730	Washer	M20*37	1	
27	207084	Plate		1	VE
28	WS080000	Spring Washer	M8	1	
29	203239	Hex Nut	M8*1.25P	1	
30	SS100200	Setscrew	M10*10	3	
31	207081	Shaft		1	
32	SS100400	Setscrew	M10*20	4	
33	NH101700	Hex Nut	M10	4	
34	NH081300	Hex Nut	M8	8	
35	207582	Cover	13mm	8	
36	SJ059200	Button Head Screw	M5*8	4	
37	207528	Plate		1	VE
101	203349	Shaft		1	
102	203348	Roller		1	
103	BB620202	Bearing	6202ZZ	2	
104	RS150000	Ext. Retaining Ring	S15	2	
201	BB620202	Bearing	6202ZZ	1	
202	203356	Ring		1	
203	203357	Shaft		1	
204	RS150000	Ext. Retaining Ring	S15	2	

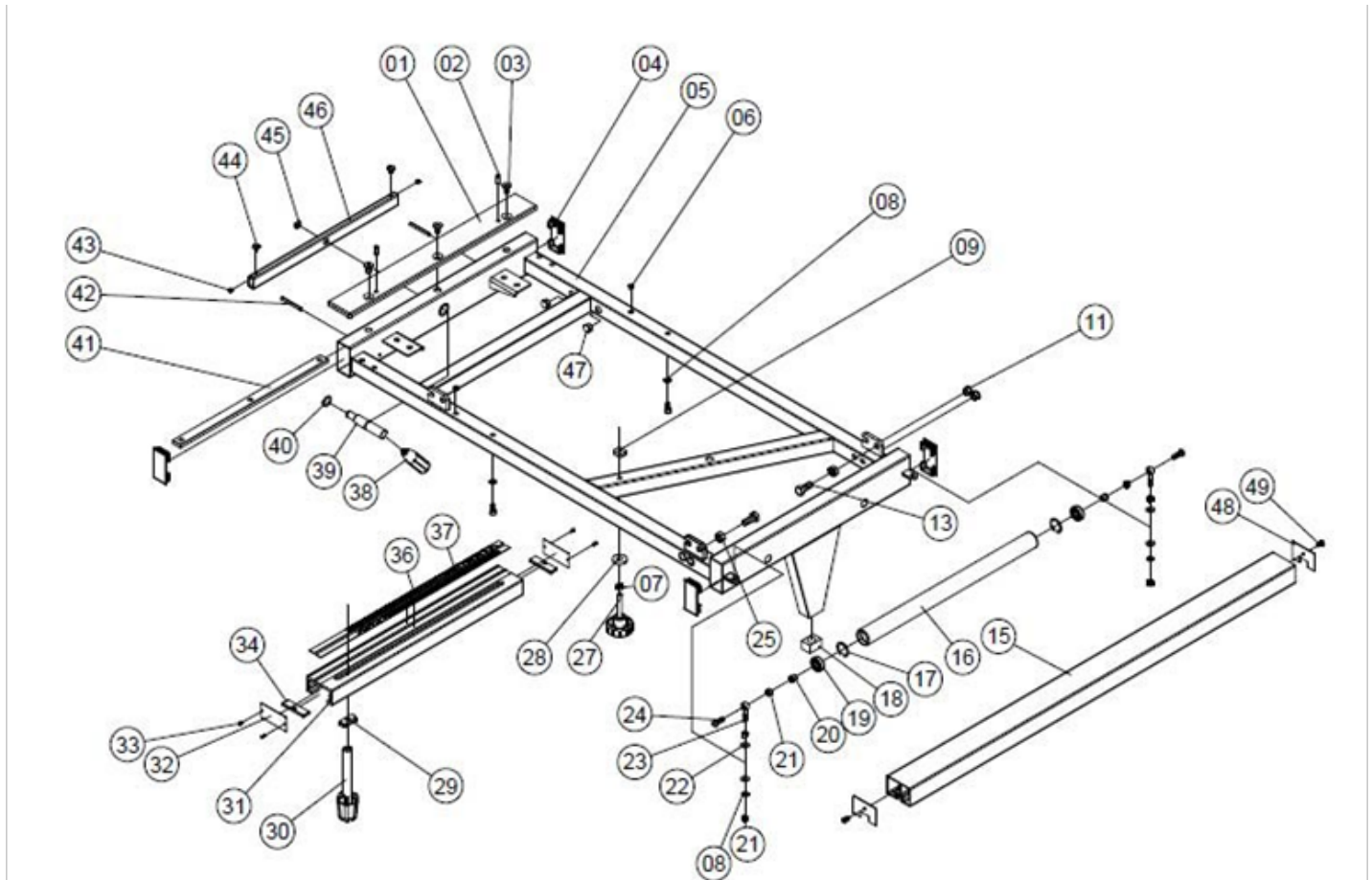

Item	Part N°	Parts Name	Size	Qty	Note
1	203116	Fixed Plate		1	
2	PS082000	Spring Pin	8×20	2	
3	SI100400	Counter Sunk Screw	M10×20	3	
4	200910	Plug	40×80	4	
5	203979	Frame		1	R
6	201576	Hole Plugs	HP-09	2	
7	NH081300	Hex Nut	M8	1	
8	WS080000	Lock Washer	M8	4	
9	201103	T-Nut	M8x1.25p	1	
11	203284	Hole Plugs	HP-19	4	
13	SH120801	Screw	M12×1.25×40	2	
15	200833	Pipe		1	
16	203302	Roller		1	
17	RR320000	Retaining Ring	R32	2	
18	203094	Plug		1	

Item	Part N°	Parts Name	Size	Qty	Note
19	BB620102A	Ball Bearing	6201ZZ	2	
20	017058	Bearing		2	
21	NH081300	Hex Nut	M8	6	
22	WF081818	Washer	M8x18	4	
23	201542	Eye Bolt	M8x40	2	
24	SJ080500	Button Head Screw	M8x25	2	
25	NH121900	Nut	M12	2	
27	200827	Knob	M8x1.25px40L	1	
28	WF083020	Washer	M8	1	
29	203122	Block		1	
30	203128	Handle		1	
31	203855	Pipe		1	X7
32	203856	Plate		2	
33	SJ039200	Button Head Screw	M3x8	4	
34	203121	Fixed Block		2	
36	207924-2	Ruler		1	
37	207924-1	Ruler		1	
38	203719	Knob		1	
39	203114	Eccentric Shaft		1	
40	RS200000	Retaining Ring	S20	1	
41	203288	Fixed Block		1	
42	PS066000	Spring Pin	6x60	2	
43	NS050800	Square Nut	M5	2	
44	203110	Screw	M5x10	2	
45	RS140000	Retaining Ring	S14	1	
46	203109	Square Pipe		1	
47	203230	Hole Plugs	HP-16	2	
48	200955	Cover		2	
49	ST040200	Tap Screw	#8x3/8"	2	
43	NS050800	Square Nut	M5	2	
44	203110	Screw	M5x10	2	
45	RS140000	Retaining Ring	S14	1	
46	203109	Square Pipe		1	
47	203230	Hole Plugs	HP-16	2	

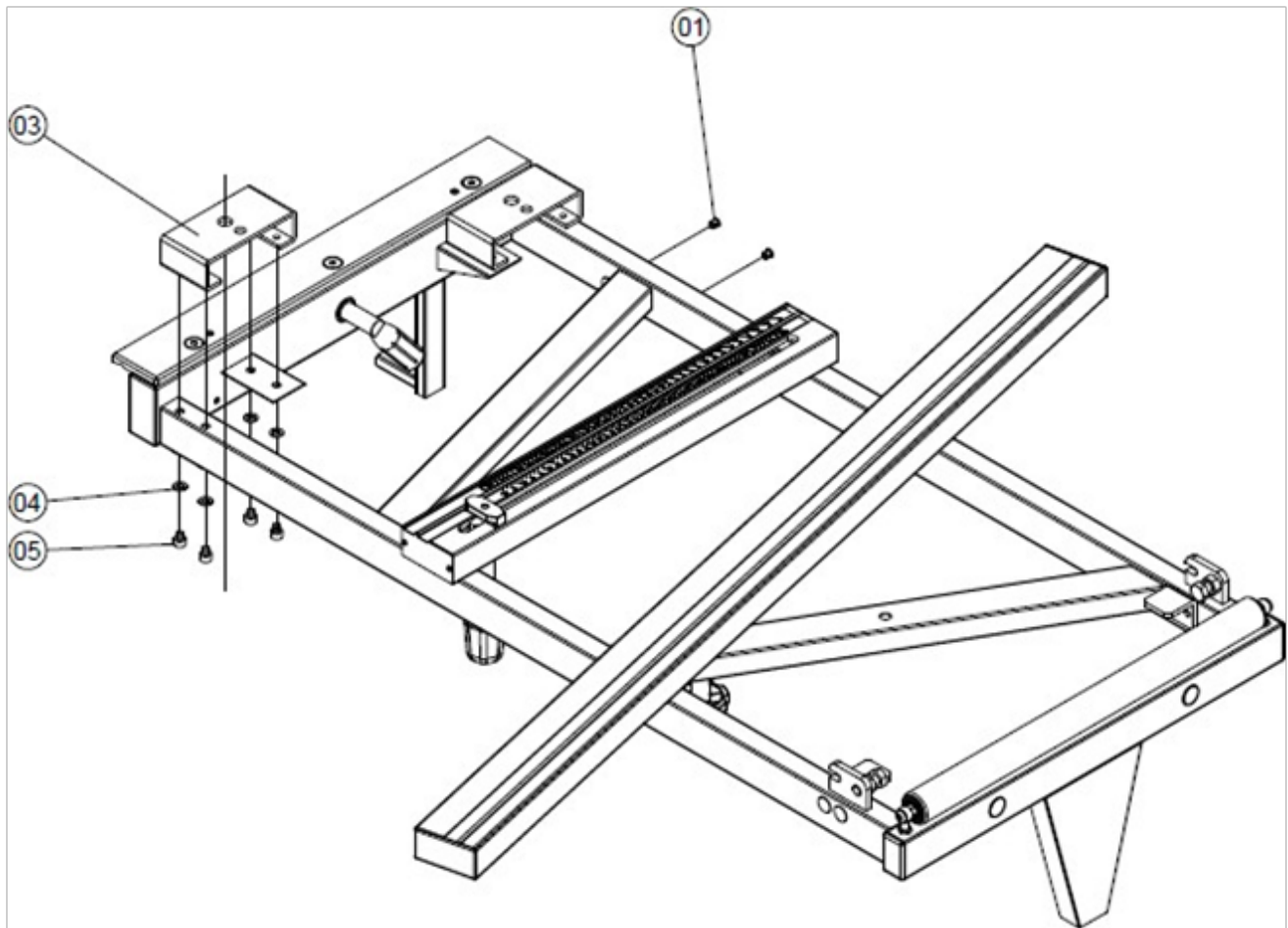

Item	Part N°	Parts Name	Size	Qty	Note
1	201576	Hole Plugs	HP-09	2	
3	207734	Fixed Plate		2	R
4	WS080000	Lock Washer	M8	8	
5	SR080200	Cap Screw	M8×10	8	

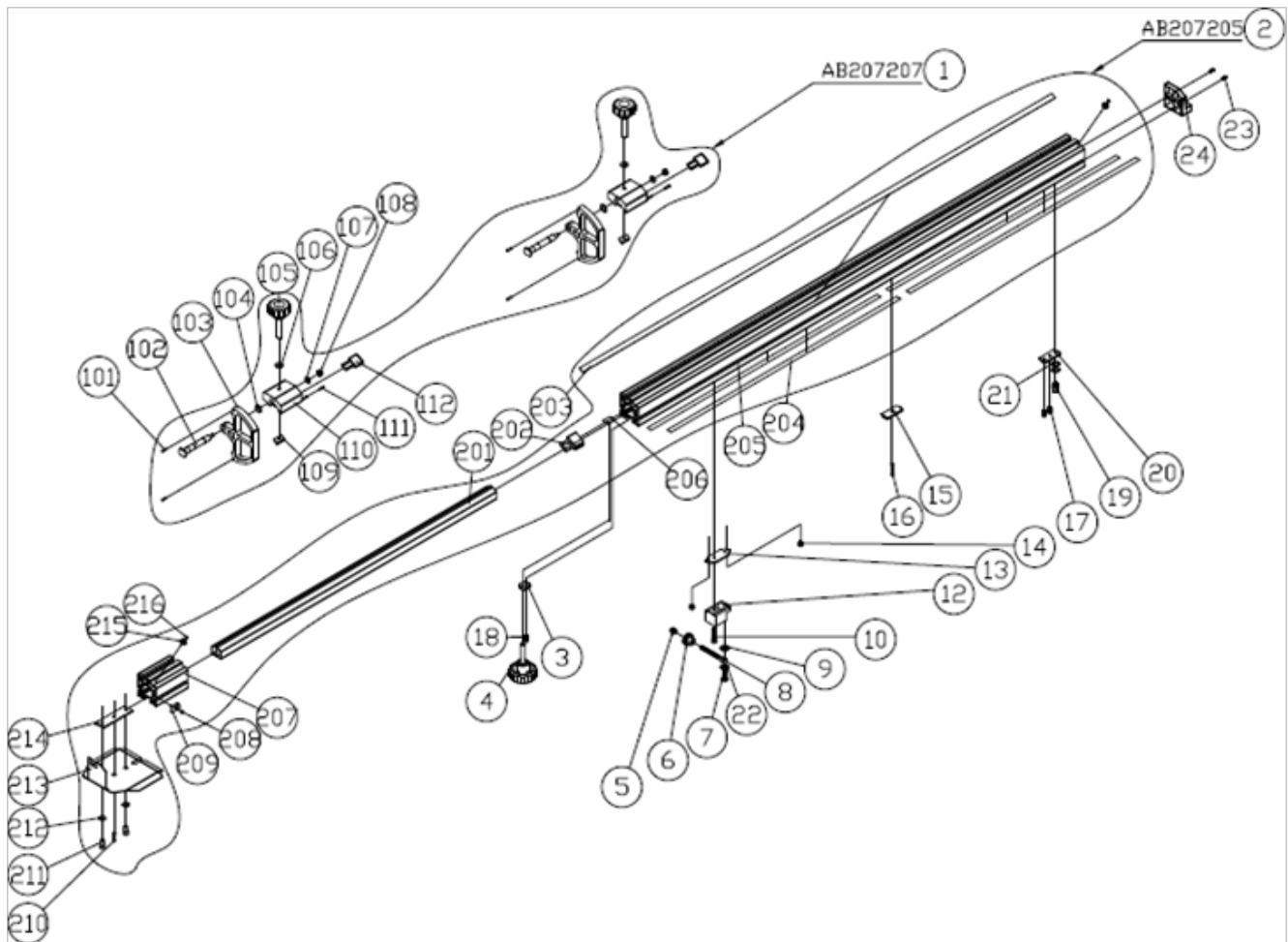

Item	Part N°	Parts Name	Size	Qty	Note
1	AB207207	Flip Stop Assembly		2	A
2	AB207205A	Ext. Fence Assembly	mm	1	S, standard
	AB207205	Ext. Fence Assembly	mm/inch	1	S, A
3	207222	Block		1	H
4	200827	Knob	M8x1.25px40L	1	H
5	NA081300	Nut	M8	1	
6	203790	Knob	M8*1.25p	1	
7	SJ080400	Button Head Screw	M8*20	1	
8	203598	Screw	M8*1.25p	1	
9	WF081818	Washer	M8*18	1	
10	SR060800	Cap Screw	M6*40	1	
12	207219	Fixed Block		1	
13	207220	Plate		1	

Item	Part N°	Parts Name	Size	Qty	Note
14	SS069100	Setscrew	M6*6	2	
15	207218	Fixed Block		1	H
16	SS080700	Setscrew	M8*35	1	H
17	SS089300	Setscrew	M8*12	2	H
18	SS089300	Setscrew	M8*12	1	H
19	200832	Rotate Shaft		1	H
20	207737	Fixed Block		1	H
21	200069	Fiber Washer	10x18	2	H
22	992601	Copper Washer	8*16*0.2	1	
23	ST049200	Tap Screw	M4x8	2	
24	207851	Rotate Block		1	
101	207223	Pipe		2	
102	207203	Shaft		1	
103	207207	Flip Stop		1	
104	207208	Washer		1	
105	207263	Knob	M8x1.25px42L	1	
106	200472	Washer	M8x20x1	1	
107	WF081818	Washer	M8x18	1	
108	207235	Nut	M8	1	
109	207200	Nut		1	
110	207201	Stop Bracket		1	
111	207223	Pipe		2	
112	207202	Magnifier		1	
201	207212-1	Extended Tube	mm	1	S,standard
	207212	Extended Tube	mm/inch	1	S
202	207213	Magnifier		1	
203	207216-1	Rule	mm	1	S,standard
	207216	Rule	mm/inch	1	S
204	205544	Wearing Tape	875x15	4	
205	207205-1	Ext. Fence		1	
206	207884	Sheet		1	
207	207205-2	Ext. Fence		1	
208	SS069100	Setscrew	M6x6	1	
209	207211	Stop Block		1	
210	SS080500	Setscrew	M8x25	1	
211	SR089400	Cap Screw	M8x16	2	

Item	Part N°	Parts Name	Size	Qty	Note
212	WF081818	Washer	M8x18	2	
213	207210	Locate Plate		1	
214	207209	Plate		1	
215	207204	Nut		2	
216	SS050100	Setscrew	M5x5	2	

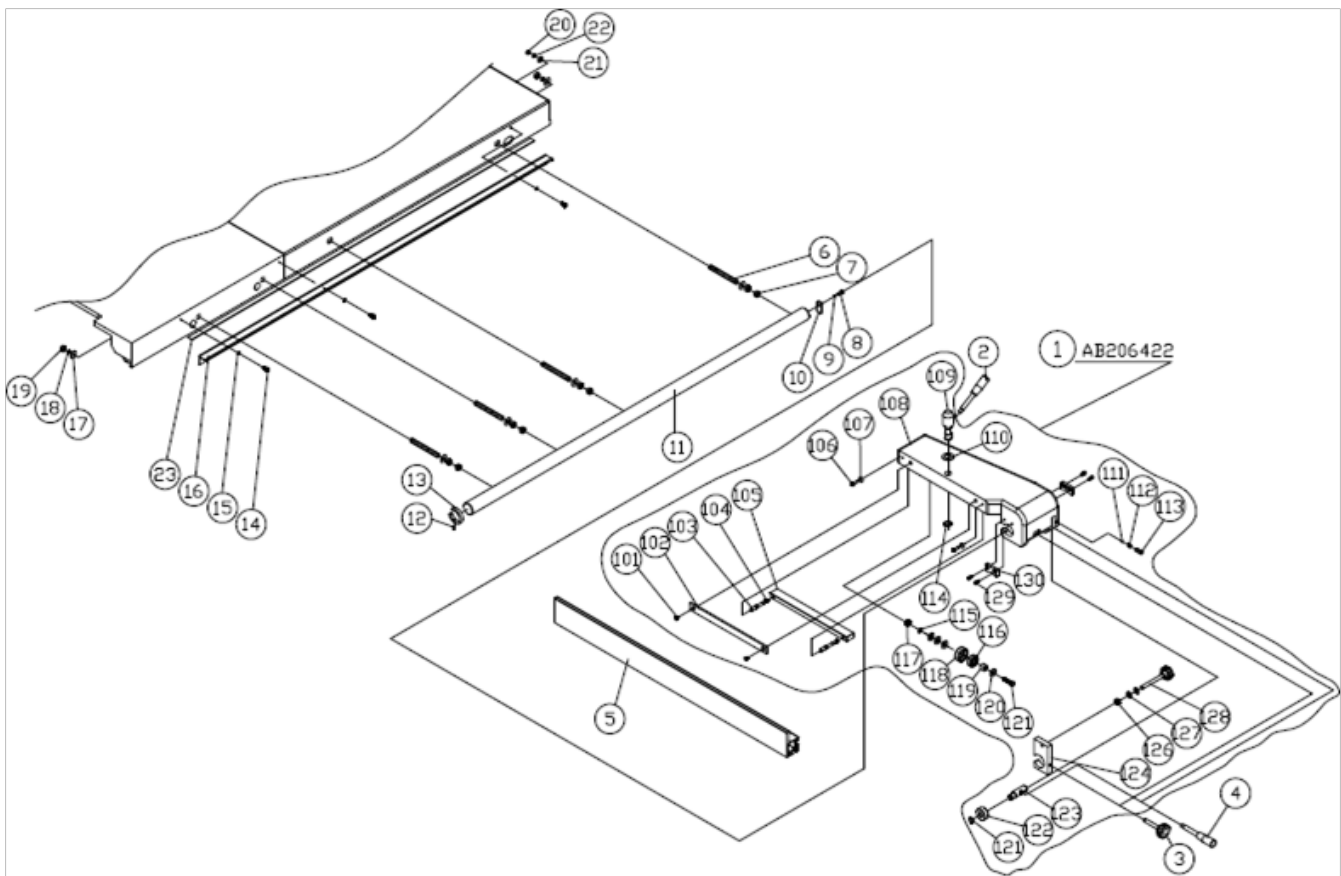

Item	Part N°	Parts Name	Size	Qty	Note
1	AB206422	Rip Fence Housing Assembly		1	A
2	200884	Handle		1	
3	206432	Knob Screw	M10*1.5p*55L	1	
4	200884	Handle		1	
5	205663	Fence Plate	1M	1	
	203191	Fence Plate	1.2M	1	X7 / S
6	200881	Screw	M12x1.75px115L	4	

Item	Part N°	Parts Name	Size	Qty	Note
7	NH121900	Hex Nut	M12	8	
8	SR089300	Cap Screw	M8x16	1	
9	WS080000	Lock Washer	M8	1	
10	206437	End Washer		1	
11	201004	Round Rail		1	
12	SS060200	Setscrew	M6x10	1	
13	200957	Ring Stop		1	
14	SJ069300	Button Head Screw	M6*12	3	H
15	WF061620	Washer	M6*16	3	H
16	207984	Measuring Rule Rail		1	
17	WF132225	Washer	M13x22x2.5	8	
18	WS120000	Lock Washer	M12	4	
19	NH121900	Hex Nut	M12	4	
20	NH061000	Hex Nut	M6	1	H
21	WF061620	Washer	M6x16x2	1	H
22	WS060000	Lock Washer	M6	1	H
23	LM206306	Ruler	mm	1	standard
	LM001042	Ruler	mm/inch	1	S
101	SI069400	Counter Sunk Screw	M6*16	2	
102	206433	Fixed Plate		1	
103	203193	Shafts		2	
104	NL081000	Lock Nut	M8	2	
105	200875	Plate		1	
106	SH069400	Hex Head Bolt	M6*16	2	
107	203179	Eccentric Ring		2	
108	206422	Seat		1	GK
109	203213	Eccentric Shaft		1	
110	WF203630	Washer	20*36	1	
111	994181	Steel Ball	8	1	
112	150099	Spring		1	
113	SS100200	Set Screw	M10*10	1	
114	RS200000	Retaining Ring	S20	1	
115	WS080000	Lock Washer	M8	1	
116	BB620202	Ball Bearing	6202ZZ	1	
117	NA081300	Hex Nut	M8	1	
118	203356	Ring		1	
119	206435	Ring		1	

Item	Part N°	Parts Name	Size	Qty	Note
121	SH080700	Hex Head Bolt	M8*35	1	
122	RS150000	Retaining Ring	S15	1	
123	203649	Ring		1	
124	203650	Shaft		1	
125	206428	Fixed Block		1	
126	NL101700	Lock Nut	M10	1	
127	200069	Washer	M10	2	
128	205114	Adjust Knob	M10*110	1	
129	SR060200	Cap Screw	M6*10	4	
130	205822	Scraper	40	2	

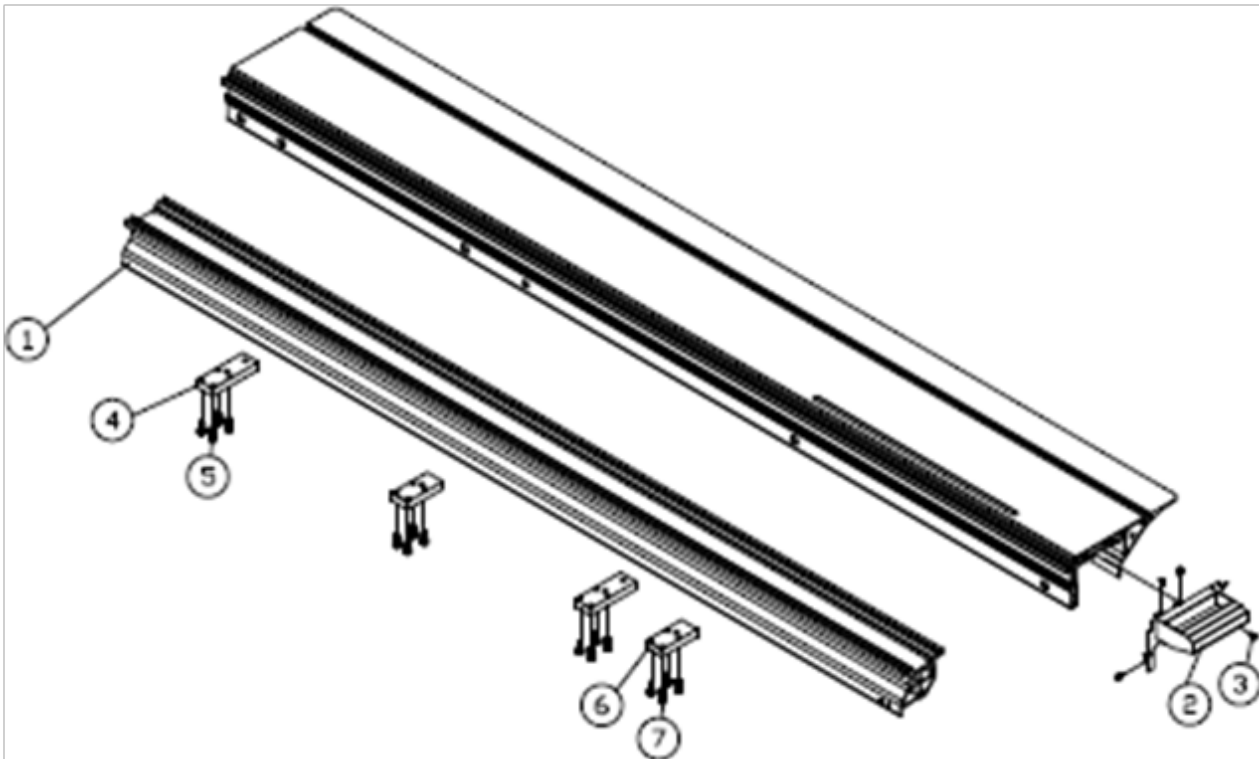

Item	Part N°	Parts Name	Size	Qty	Note
1	2395250D	Table	395x2500mm	1	S
2	203423	Hander		1	T3
3	SH050200	Hex Head Bolt	M5*10	4	
4	203520	Fixed Block		2	
5	SR080500	Cap Screw	M8*25	8	
6	205246	Fixed Block		2	
7	SR080500	Cap Screw	M8*25	8	

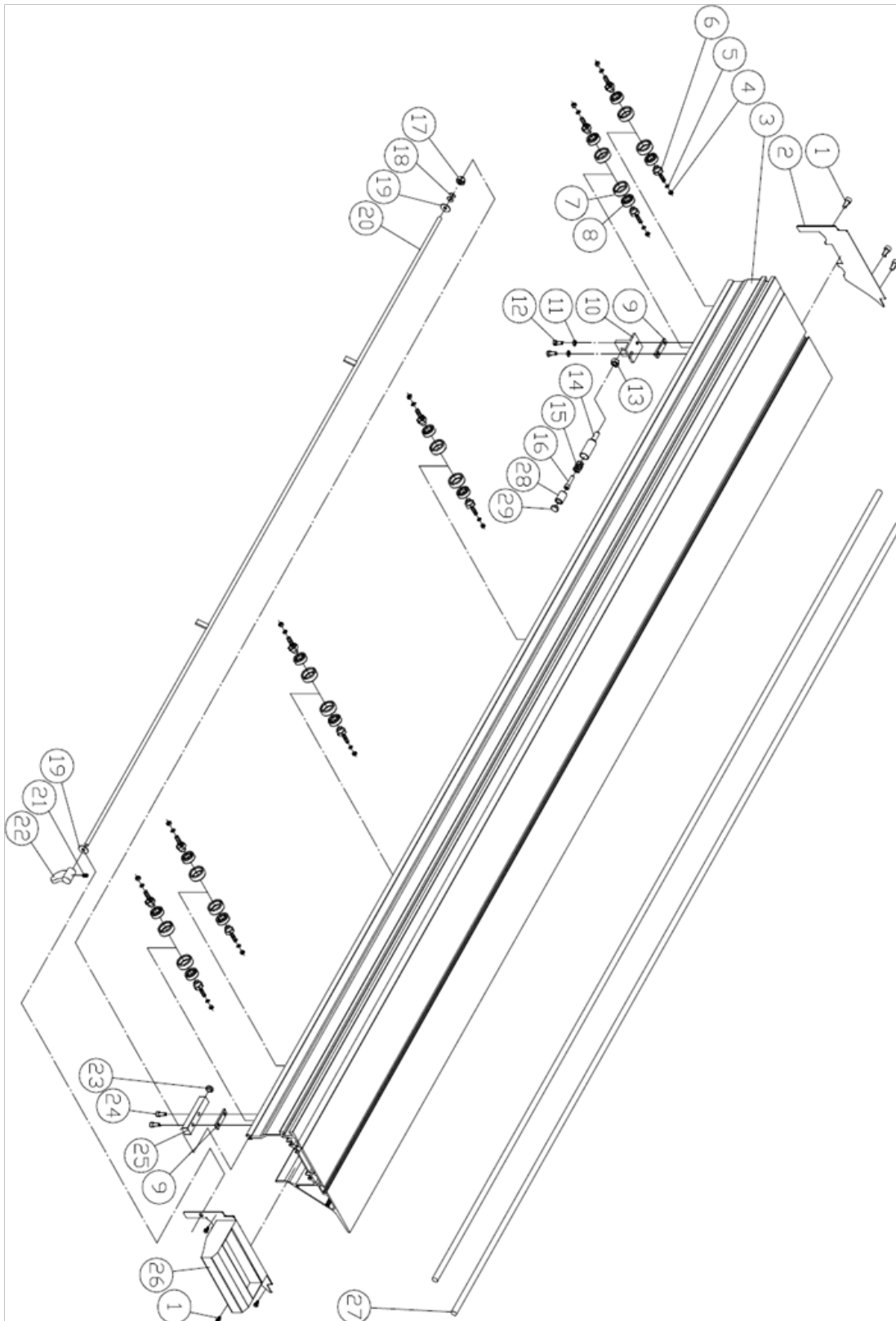

Item	Part N°	Parts Name	Size	Qty	Note
1	SJ069300	Screw	M6*12	6	
2	2375320M-1	Plate		1	T3
3	2375320M-2	Base		1	
4	NH101700	Hex Nut	M8	12	
5	WE100000		M10	12	
6	2375320M-3	Eccentric shaft		12	
7	203356	Ring		12	
8	BB620202	Ball Bearing	6202ZZ	12	
9	203703	Block		2	
10	203555	Fixed Base		1	
11	WS080000	Lock Washer	M8	2	
12	SH080400	Hex Head Bolt	M8*20	2	
13	NH101700	Hex Nut	M10	1	
14	2375320M-4	Spring		1	
15	2375320M-5	Ring		1	
16	SR101000	Cap Screw	M10*50	1	
17	NL101700	Lock Nut	M10	1	
18	204263	Set Screw	10*20	2	
19	WF102010	Washer	10*20*1t	2	
20	2375320M-6	Lever		1	
21	SS069200	Setscrew	M6*8	1	
22	2375320M-7	Hander		1	
23	2375320M-8	Base		1	
24	SR100400	Cap Screw	M10*20	2	
25	2375320M-9	Fixed Block		1	
26	2375320M-10	Hander		1	T3
27	2375320M-11	Cylinder		2	
28	2375320M-12	Ring		1	
29	2375320M-13	Base		1	

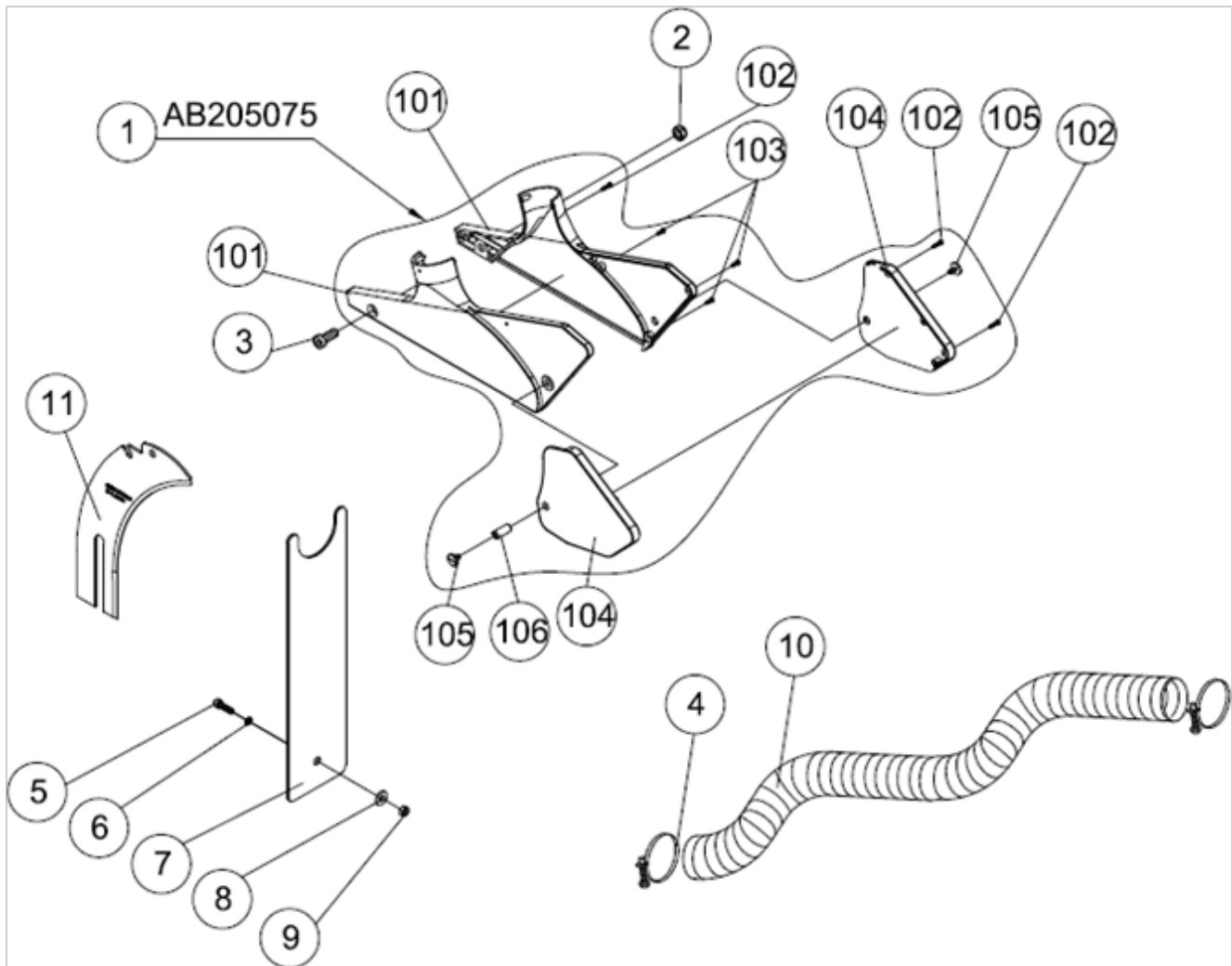

Item	Part N°	Parts Name	Size	Qty	Note
1	AB205075	Hood Assembly		1	A
2	NL101700	Lock Nut	M10	1	
3	205162	Cap Screw	M10x25	1	
4	200535	Hose Clamp	2-1/2"	2	
5	SR100500	Cap Screw	M10x25	1	
6	WS100000	Lock Washer	M10	1	
7	200965	Hose Support Plate		1	
8	WF102025	Washer	M10x20	1	
9	NL101700	Hex Nut	M10	1	
10	200536	Hose	∅64x3000	1	
11	205067	Plate		1	

Item	Part N°	Parts Name	Size	Qty	Note
101	205075	Hood		1	
102	ST029404	Screw	M3×16	3	
103	ST029304	Screw	M3×12	3	
104	205076	Hood		1	
105	203110	Screw	M5×10	2	
106	205124	Shaft		1	

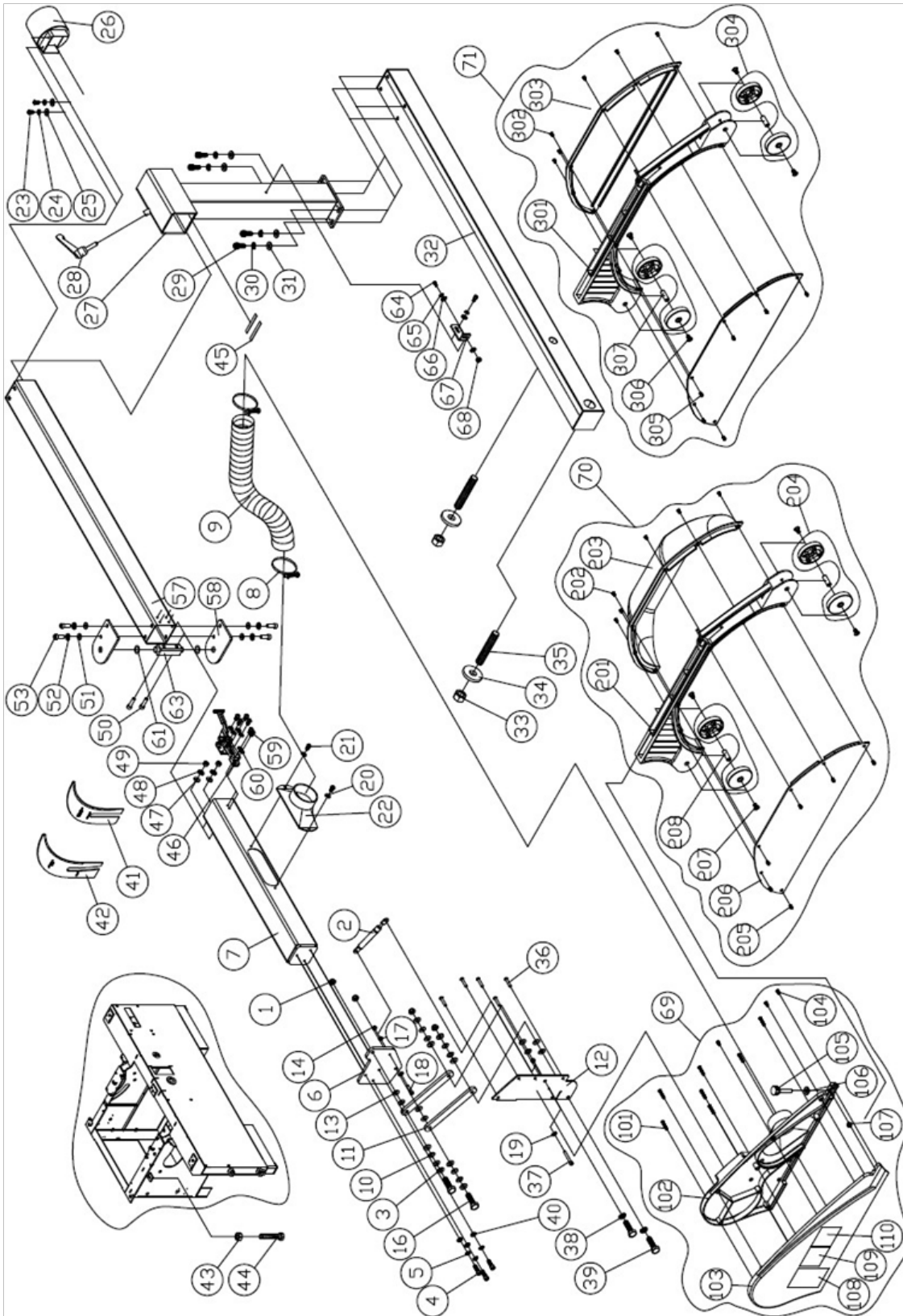

Item	Part N°	Parts Name	Size	Qty	Note
1	NL101700	Lock Nut	M10	4	
2	205004	Gas Expansion Cylinder		1	
3	WF102020	Washer	M10*20	8	
4	SR060400	Cap Screw	M6*20	3	H
5	WS060000	Lock Washer	M6	3	H
6	207987	Fixed Plate		1	
7	207970	Arm		1	R
8	204158	Hose Clamp	3-1/4"	2	
9	HS330004	Hose	3"x42cm	1	
10	204263	Washer	10x20	8	
11	207981	Link		2	
12	207985	Fixed Plate		1	
13	992609	Copper Washer	20x10x0.5t	8	
14	NL061000	Lock Nut	M6	2	
16	SH100700	Hex Head Bolt	M10*35	2	
17	NH061000	Hex Nut	M6	1	
18	SR060500	Cap Screw	M6*25	1	
19	WS060000	Lock Washer	M6	2	
20	WS060000	Lock Washer	M6	2	H
21	SJ069300	Cap Screw	M6*12	2	H
22	204061	Dust Port		1	
23	SJ069300	Cap Screw	M6*12	2	
24	WS060000	Lock Washer	M6	2	
25	WF061920	Washer	M6*19	2	
26	206390	Dust Port		1	R
27	206388	Fixed Bracket		1	R
28	201109	Fasten Handle	M10x35	1	H
29	SR080500	Cap Screw	M8x25	4	H
30	WS080000	Lock Washer	M8	4	H
31	WF081818	Washer	M8x18	4	H
32	206391	Fixed Bracket		1	R
33	NH203000	Hex Nut	M20	2	
34	203338	Washer	22*60*t8	2	
35	205116	Screw	M20*130	2	
36	SJ060600	Button Head Screw	M6*30	5	
37	SR060900	Cap Screw	M6*45	1	
38	WS100000	Lock Washer	M10	2	

Item	Part N°	Parts Name	Size	Qty	Note
39	SH100700	Hex Head Bolt	M10*35	2	
40	WF061920	Washer	M6*19	3	H
41	205073	Plate	300~350	1	
42	205032	Plate	350~400	1	S
43	NH121900	Hex Nut	M12	1	
44	SH121400	Hex Head Bolt	M12X70	1	
45	201039	Pad		8	
46	205358	Elbow Type Clamp		1	
47	WF081818	Washer	M8x18	2	
48	WS080000	Lock Washer	M8	2	
49	NH081300	Hex Nut	M8	2	
50	SR080600	Cap Screw	M8x30	2	
51	WF081818	Washer	M8x18	4	
52	WS080000	Lock Washer	M8	4	
53	SR080500	Cap Screw	M8x25	4	
57	207971	Square Tube		1	R
58	207973	Plate		2	R
59	SJ060200	Cap Screw	M6x10	6	
60	WS060000	Lock Washer	M6	6	
61	992627	Copper Washer	24*16*0.3t	2	
63	207975	Shaft		1	
64	SR060400	Cap Screw	M6*20	2	
65	WS060000	Lock Washer	M6	2	
66	WF061620	Washer	M6×16	3	
67	207776	Fixed Plate		1	
68	NH061000	Hex Nut	M6	1	
69	AB207866	Rear Cover ASM		1	
70	AB205355	Protection Hood ASM		1	
71	AB205356	Protection Hood ASM			
101	ST030500	Tap Screw	M3.5x25	7	
102	207866	Rear Cover		1	
103	207865	Front Cover		1	
104	ST040200	Tap Screw	M4x10	3	
105	207882	Knob		1	
106	WF081818	Washer	M8x18	1	
107	NH081300	Hex Nut	M8	1	
108	LM207031	Warning Label		1	

Item	Part N°	Parts Name	Size	Qty	Note
109	LM207032	Warning Label		1	
110	LM207033	Warning Label		1	
201	207867	Guard		1	
202	SP040200	Pan Head Screw	M4*10	6	
203	205355	Protection Hood		1	
204	AB207868	Roller ASM		2	
205	SP040200	Pan Head Screw	M4*10	6	
206	205356	Protection Hood		1	
207	SI060200	Counter Sunk Screw	M6*10	4	
208	207883	Shaft		2	
301	207867	Guard			
302	SP040200	Pan Head Screw	M4*10		
303	205356	Protection Hood			
304	AB207868	Roller ASM			
305	SP040200	Pan Head Screw	M4*10		
306	SI060200	Counter Sunk Screw	M6*10		
307	207883	Shaft			

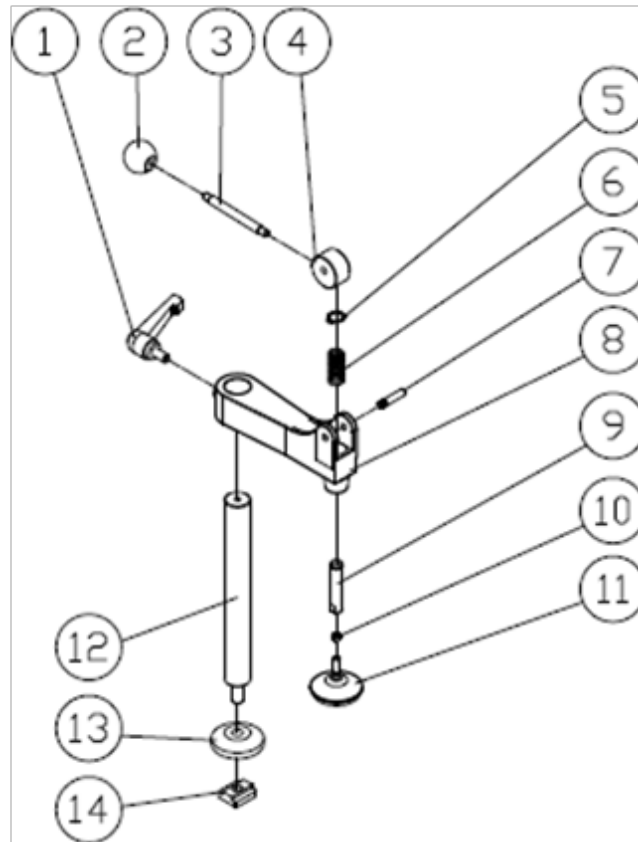

Item	Part N°	Parts Name	Size	Qty	Note
1	207143	Adjust Handle		1	
2	100271	Ball Knob	M8×P1.25	1	
3	207070	Handle Bar		1	
4	207067	Cam		1	
5	RS140000	Ext. Retaining Ring	S14	1	
6	207069	Spring		1	
7	207145	Pin		1	
8	207065	Down Press		1	
9	207068	Shaft		1	
10	NH602300	Hex Nut	5/16	1	
11	200807	Large Washer		1	
12	205253	Shaft		1	
13	200809	Washer		1	
14	201855	T-Nut		1	S, B
	205255	T-Nut		1	S, D

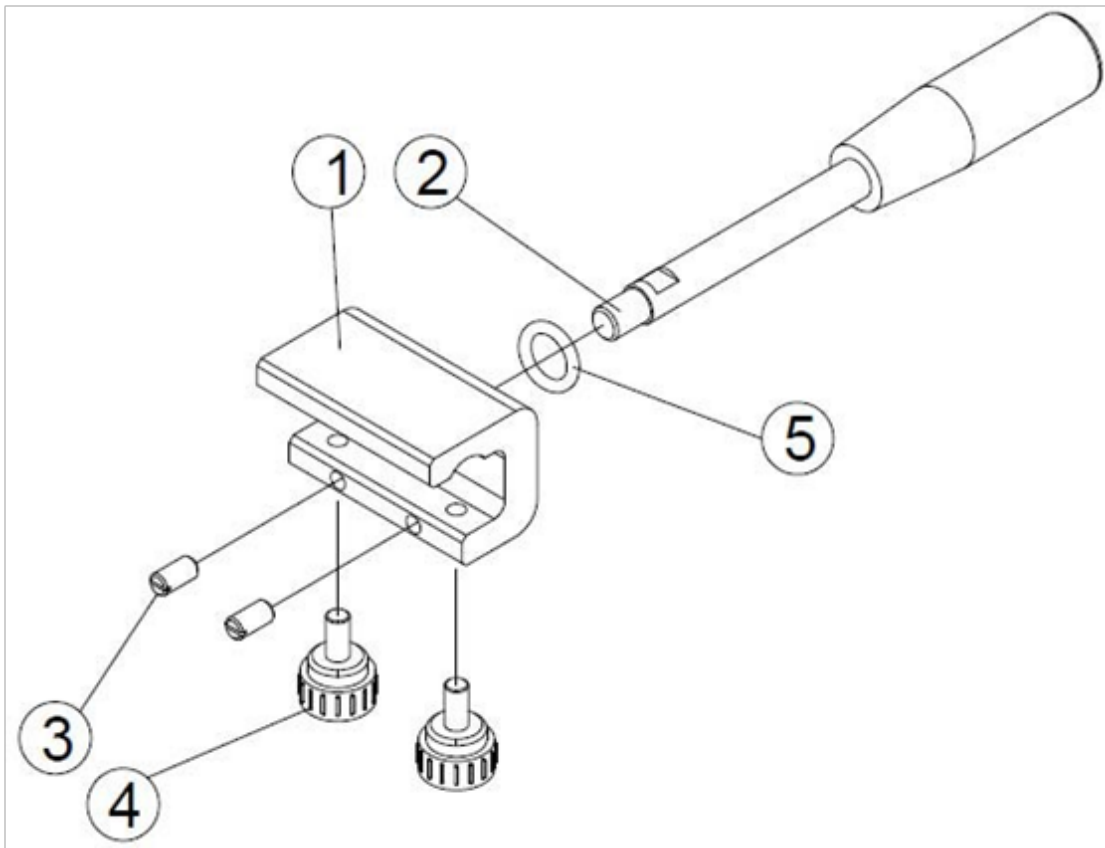

Item	Part N°	Parts Name	Size	Qty	Note
1	205264	Block		1	
2	200939	Handle		1	
3	203238	Set Screw	M8×16	2	D Sliding
	SS080500	Set Screw	M8x25	2	C Sliding
4	203720	Knob	M8×16	2	
5	992492	PLASTIC WASHER	12x30 t=3	1	

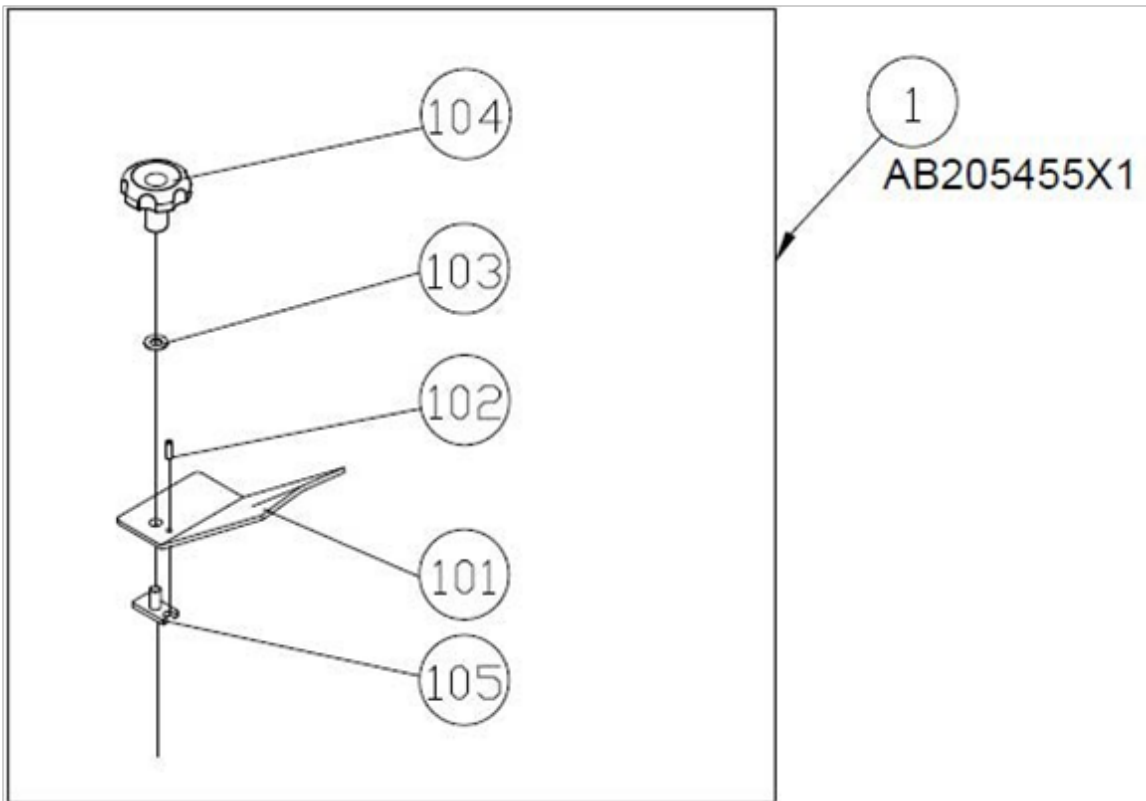

Item	Part N°	Parts Name	Size	Qty	Note
1	AB205455X1	Edge Shoe Plate Assembly		1	
101	205455	Edge Shoe Plate		1	X1
102	PS051800	Spring Pin	5x18	1	
103	WF102025	Washer	M10x25	1	
104	203718	Knob	M10	1	
105	201829	T-Nut	M10x1.5p	1	

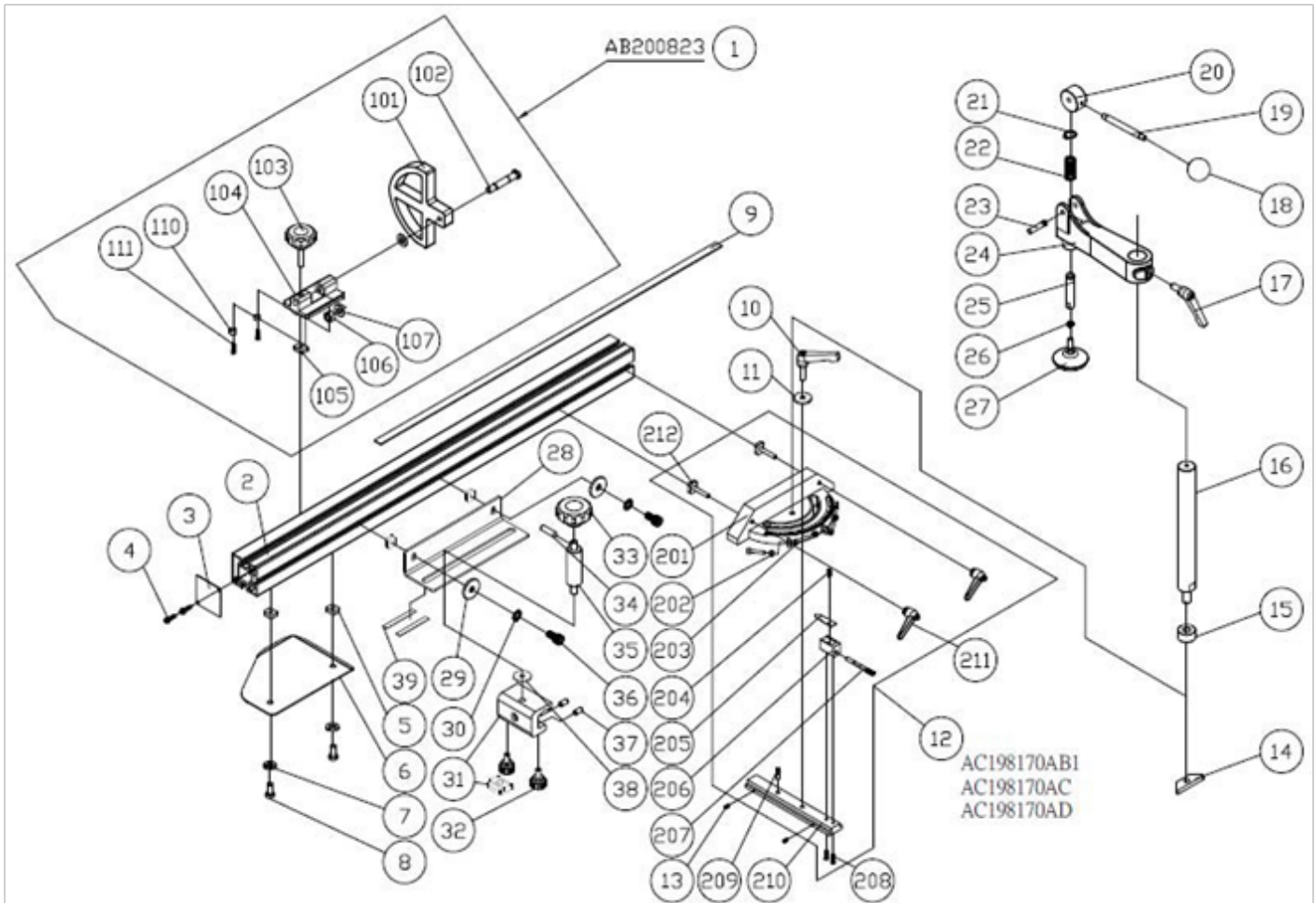

Item	Part N°	Parts Name	Size	Qty	Note
1	AB200823	Flip Stop Assembly	101-111	1	A
2	205758	Square Fence		1	
3	200830	Cover		1	
4	ST040200	Tap Screw	M4x10	2	
5	201103	T-Nut	M8x1.25p	4	
6	205715	Locate Plate		1	
7	WS080000	Lock Washer	M8	2	
8	SJ089400	Button Head Screw	M8x16	2	
9	LM200143	Rule	From right 0-1000(mm/inch)	1	S, standard
	LM200149	Rule	from right 0-1000(m	1	S
10	200814	Fasten Handle		1	
11	WF083030	Flat Washer	M8x30	1	
12	AC198170AB1	Miter Gauge Assembly	For B1,F type	1	S, A
	AC198170AC	Miter Gauge Assembly	For C type	1	S, A
	AC198170AD	Miter Gauge Assembly	For D type	1	S, A

Item	Part N°	Parts Name	Size	Qty	Note
13	201632	Spring plungers with ball	M4×9	2	
14	207666	Locate Plate		1	
15	207668	Ring		1	
16	205253	Shaft		1	
17	207143	Adjust Handle		1	
18	100271	Ball Knob	M8×P1.25	1	
19	207070	Handle Bar		1	
20	207067	Cam		1	
21	RS140000	Ext. Retaining Ring	S14	1	
22	207069	Spring		1	
23	207145	Pin		1	
24	207065	Down Press		1	
25	207068	Shaft		1	
26	NH602300	Hex Nut	5/16	1	
27	200807	Large Washer		1	
28	205810	Locate Plate		1	S / D
	205811	Locate Plate		1	S / E
29	WF083030	Washer	M8X30	2	
30	WS080000	Lock Washer	M8	2	
31	205760	Block		1	S / D
	201855	T-Nut		1	S / E
32	203720	Knob	M8×16	2	S / D
33	100203	Lock Knob	M10	1	
34	PP052000	Pin	5×20	1	
35	205757	Shaft		1	
36	SR089400	Cap Screw	M8×20	2	
37	203286	Set Screw	M8×16	2	S / D
38	WF123025	Washer	M12X30X2.5t	1	S / D
39	201039	Pad		2	S / E
201	198170A	Miter Gauge Body		1	
202	NH050800	Hex Nut	M5	3	
203	SR050500	Cap Screw	M5×25	3	
204	SP049300	Pan Head Bolt	M4×12	1	
205	201366	Pointer		1	
206	201365	Fixed Block		1	
207	201367	Stop Bar		1	
208	SP049400	Pan Head Bolt	M4×16	2	

Item	Part N°	Parts Name	Size	Qty	Note
209	198174	Shaft		1	
210	201364B1	Fixed Base		1	B1,F type
	205721	Fixed Base		1	C type
	205254	Fixed Base		1	D type
211	017003	Adjust Handle		2	
212	207667	T-Bolt		2	

Item	Part N°	Parts Name	Size	Qty	Note
1	IC207010	POWER CORD	CE	1	CE.3PH
		VDE	2.5x4Cx250CMx3Y1R4		
	IC207019	POWER CORD	CSA(5HP)	1	CSA.3PH_5HP
		CSA	14AWGx4Cx2.5Mx6Y2R.E		
	IC207022	POWER CORD	CSA(7.5HP)	1	CSA.3PH_7.5HP
		CSA	12AWGx4Cx2.5Mx6Y2R.E		
	IC207027	POWER CORD	CE	1	CE.1PH
		VDE	2.5x3Cx250CMx2Y1R3		
	IC206302	POWER CORD	CSA(3HP)	1	CSA_1PH_3HP
		CSA	14AWGx3Cx250CMx4Y2R.E		
	IC206304	POWER CORD	CSA(5HP)	1	CSA_1PH_5HP
		CSA	12AWGx3Cx250CMx4Y2R.E		
	IC207060	POWER CORD	CSA(5HP)	1	CSA.1PH_5HP
		CSA 1 5HP	8AWGx1Cx2.9Mx2Y.		
	IC207061	POWER CORD	CSA(5HP)	1	CSA.1PH_5HP
		CSA 1 5HP	8AWGx1Cx2.9Mx2Y.		
IC207062	POWER CORD	CSA(5HP)	1	CSA.1PH_5HP	
	CSA 1 5HP	8AWGx1Cx2.9Mx1Y1R.			
2	IM207001	MOTOR CORD	CE	1	CE.3PH
		VDE	2.5mm*4C*2.7M*3Y5R		
	IM207004	MOTOR CORD	CSA(5HP)	1	CSA.3PH_5HP
		CSA	14AWGx4Cx2.7Mx3Y5R.E		
	IM207005	MOTOR CORD	CSA(7.5HP)	1	CSA.3PH_7.5HP
		CSA	12AWGx4Cx2.7Mx3Y5R.E		
	IM207003	MOTOR CORD	Y	1	CE.CSA+Y
		VDE	2.0x7Cx270CMx6Y8R.E		
IM207010	MOTOR CORD	CE	1	CE.1PH	
	VDE	2.5mm*3C*2.7M*2Y4R			

Item	Part N°	Parts Name	Size	Qty	Note
2	IM207009	MOTOR CORD	CSA	1	CSA.1PH_3HP
		CSA	14AWGx3Cx2.7Mx2Y4R.E		
	IM207005	MOTOR CORD	CSA(7.5HP)	1	CSA.1PH_5HP
		CSA	12AWGx4Cx2.7Mx3Y5R.E		CSA.3PH_7.5HP
	IM207014	MOTOR CORD	CSA(5HP)	1	CSA.1PH_5HP
		CSA	8AWGx1Cx2.7Mx1Y1R.		
	IM207015	MOTOR CORD	CSA(5HP)	1	CSA.1PH_5HP
		CSA	8AWGx1Cx2.7Mx1Y1R		
	IM207016	MOTOR CORD	CSA(5HP)	1	CSA.1PH_5HP
	CSA	8AWGx1Cx2.7Mx2R.			
*3	IC207028	CONTROL PANEL CORD		1	CE.CSA
			0.75x7Cx40CMx12Y.E		
*5	IC207013	STOP CORD	CE	1	S,CE,
		VDE	0.75x2Cx2.5Mx3Y1		
	IC207068	STOP CORD	CSA	1	S,CSA
		CSA	18AWGx2Cx2.5Mx3Y.E		
7	IM207002	SCORING MOTOR CORD	CE	1	CE.3PH.
		VDE-scoring motor	1.0x4Cx1.8Mx6Y2R.E		
	IM207006	SCORING MOTOR CORD	CSA	1	CSA.3PH.
		CSA-scoring motor	16AWGx4Cx1.8Mx6Y2R.E		
	IM207011	SCORING MOTOR CORD	CE	1	CE.1PH.
		VD-scoring motor	1.0x3Cx1.8Mx4Y2R.E		
	IM207013	SCORING MOTOR CORD	CSA	1	CSA.1PH.
	CSA-scoring motor	16AWGx3Cx1.8Mx4Y2R.E			
8	IC200802	POWER CORD	CE	1	CE.3PH.
		VDE	2.5x4Cx55CMx6Y2R.E		
	IC207020	POWER CORD	CSA(5HP)	1	CSA.3PH_5HP
		CSA	14AWGx4Cx0.55Mx6Y2R.E		
	IC207023	POWER CORD	CSA(7.5HP)	1	CSA.3PH_7.5HP
		CSA	12AWGx4Cx0.55Mx6Y2R.E		
	IC200802-1	POWER CORD	CE	1	CE.1PH.
		VDE	2.5x3Cx55CMx4Y2R.E		
	IC207030	POWER CORD		1	CSA.1PH_3HP
		CSA	14AWGx3Cx55CMx4Y2R.E		
	IC207036	POWER CORD	CSA(5HP)	1	CSA.1PH_5HP
		CSA 1Ø 5HP	8AWGx1Cx0.55Mx2Y.		
IC207037	POWER CORD	CSA(5HP)	1	CSA.1PH_5HP	

Item	Part N°	Parts Name	Size	Qty	Note
8		CSA7 1 5HP	8AWGx1Cx0.55Mx2Y		
*9	IC200804	CONTROL SWITCH CORD		2	
			18x10CMx2Y.E		
*10	IC200805	CONTROL SWITCH CORD		2	
			18x22CMx2Y.E		
11	IC207015	BRAKE CORD	2P	1	S,CE
		VDE	0.75x2Cx2.5Mx2I2		
	IC207055	BRAKE CORD	2P	1	S,CSA
		IC207055	18AWGx2Cx2.5Mx2I2		

8 Terms of Warranty

MAKSIWA assures the owner that their equipment, identified by the Serial number issued on the Warranty Terms.

The equipment under warranty, for two (2) years, is as followed:

1. The warranty period begins on the date of the Warranty Terms below.
2. Within the warranty period, the manual labor and the components replaced by manufacturing defect will be provided for free if duly proved by Maksiwa Service.
3. Third-party manufacturing equipment that makes up the MAKSIWA equipment (such as motors, electrical equipment, belts etc.) are subject to the terms and conditions of warranty of their respective manufacturers.
4. In case an exchange of machine is needed, please return the defective part or machine to MAKSIWA.
5. All workplace adaptations for the equipment are under the responsibility of the machine owner.
6. If you notice any defect or malfunction when receiving the equipment, get in touch immediately with the manufacturer or Dealer. Do not turn it on.
7. Not included in this warranty is any technical visits aimed at cleaning or adjustments caused by wear, resulting from normal use of the equipment.
8. The warranty does not cover problems caused by mistreatment, carelessness, misuse or inappropriate use of the functions designed for this equipment in this manual, as well as poorly executed operations by untrained operators to operate it.
9. MAKSIWA is not responsible for lost productivity, direct or indirect damages caused to the owner of the equipment or to third parties, or any other expense, including lost profits.
10. This equipment requires the use of a dust collection system with a minimum of 2 hp.
11. Even under warranty, you may lose its validity as follows:
 - a) Application of non-original components;
 - b) Alteration of its original features;
 - c) Lack of proper maintenance;
 - d) Improper use of the equipment;
 - e) Change in equipment or electronic connections;
 - f) Damage caused by mechanical shock or exposure to unsuitable conditions (humidity, salt spray, corrosive agents, etc.);
 - g) Damage caused by bad weather (floods, flooding, lightning, power outages etc.);
 - h) Maksiwa is not responsible for damages to electrical components cause by power variation in your area.

h) Removable of safety equipment will void your warranty. (Riving Blade, Blade Cover, etc.).

For your safety, trust the repairs, maintenance and adjustments (including inspection and replacement) for technical assistance recommended by MAKSIWA, always use genuine spare parts and accessories, reassembling to its original machine the same way.

MODEL:

SERIAL NUMBER:

DATE:

LOT NUMBER:

Imported by:

Maksiwa International Inc.

4100 N Powerline Rd, Suite D3

Pompano Beach, Florida

ZIP Code: 33073

Telephone: +1 (754) 205-6717 | Call us free: +1 (844) 319-6594

E-mail: customer.service@maksiwa.com

www.maksiwa.com