



DE.1200/3

Wood Jointer

INSTRUCTION MANUAL



Attention: Read this manual before using your machine.

INSTRUCTION MANUAL

Important information you should know:

• The images in this manual are illustrative and are meant to demonstrate the correct operation of your product, there may be small changes in relation to the images.

On-Line Support: In our YouTube Channel you will find several videos that will help you with Maksiwa's machines. To use the QR CODE.



READ ALL INSTRUCTIONS

CAUTION:

WHEN DOING MAINTENANCE, REPLACE ONLY WITH IDENTICAL PARTS. Repair or replace damaged wiring.

GROUNDING INSTRUCTIONS

• THIS JOINTER MUST BE CONNECTED TO A GROUNDED WIRING SYSTEM or to a system with an equipment-grounding conductor. In malfunction event, grounding provides a path of least resistance for electric current to reduce the risk of electric shock. This wood jointer is equipped with an electric cord having an equipment grounding conductor and a grounding plug. The plug must be connected into a matching outlet provided – if it will not fit the outlet; have the proper outlet installed by a qualified electrician. Improper connection of the equipment-grounding conductor can result in a risk of electric shock and/or malfunction. If repair or replacement of the electric cord or plug is necessary, do not connect the equipment-grounding conductor to a live terminal. Check with a qualified electrician or service personnel if the grounding instructions are not completely understood or if in doubt as to whether the wood jointer is properly grounded. Use only 3-wire extension cords that have 3-prong grounding plugs and 3-pole receptacles that accept the wood jointer's plug.

• REPAIR OR REPLACE A DAMAGE OR WORN CORD IMMEDIATELY. When servicing use only identical replacement parts.

• USE PROPER EXTENSION CORD. Make sure your extension cord is in good condition. When using an extension cord, be sure to use one heavy enough to carry the current your wood jointer will draw. undersized cord will cause a drop in line voltage

An undersized cord will cause a drop in line voltage resulting in loss of power and overheating. For cord length of up to 50 feet, use a cord of 14 gauge. For a cord length of 50 to 100 feet, use a cord of 12 gauge. A cord length over 100 feet is not recommended. If in doubt, use the next heavier gauge. Smaller the gauge number, heavier the cord.

• This jointer is intended for use on a circuit that has an outlet similar to the one illustrated in Sketch A. The jointer has a grounding plug similar to the plug illustrated in Sketch A. Make sure the jointer is connected to an outlet having the same configuration as the plug. No adapter is available or should be used with this wood jointer. If the machine must be reconnected for use on a different type of electric circuit, the reconnection should be made by qualified service personnel; and after reconnection, the wood jointer should comply with all local codes and ordinances.

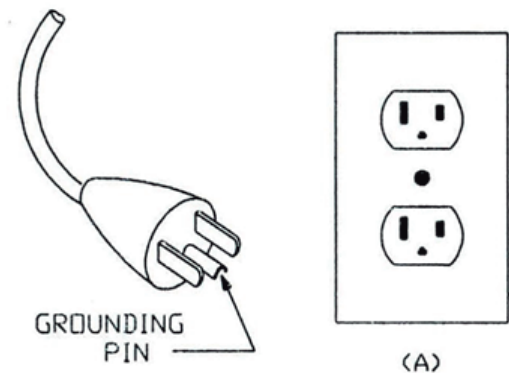

SAFETY INSTRUCTIONS FOR ALL EQUIPMENTS

! WARNINGS

- Keep a clean work surface. Cluttered areas and work surfaces are invite accidents.
- Do not use the wood jointer in hazardous environments. Do not use machine in damp or wet locations or exposed to rain. Keep well-lit work area.
- Keep children away. Visitors should be kept safe distance from work area.
- Make the workplace childproof making use of padlocks, master keys or removing the ignition key.
- Do not force tool. It will perform the job better and safer for the intended use.
- Keep children away. Visitors should be kept safe

distance from work area.

- Make the workplace childproof making use of padlocks, master keys or removing the ignition key.
- Do not force tool. It will perform the job better and safer for the intended use.

- Use appropriate equipment. Do not wear loose clothing, gloves, chains, rings, bracelets or other accessories that could become caught in moving parts.

- It is recommended wearing shoes with non-slip soles. Use protection for the hair in order to hold them.

- Always wear safety glasses. Also use hearing protection.

- Do not overreach on the equipment. Maintain balance and feet in comfortable position at all times.

- Keep all tools in order. Keep tools sharp and clean for better and safer performance. Follow the instructions for lubricating and changing accessories.

better and safer performance. Follow the instructions for lubricating and changing accessories.

- Unplug the machine before servicing or changing accessories such as scissors, cutters etc.

- Reduce the risk of unintentional starting. Ensure that the switch is in the "OFF" position (off) before connecting the wire to the plug.

- Use recommended accessories. See the instruction manual to check recommended accessories. Improper use of accessories may cause risk of injury to persons.

- Never step on the machine. May occur serious accident if the machine is dented or if parts are accidentally touched.

- Check for damaged parts. Before continuing the use of wood jointer, a guard or other part that is damaged should be examined carefully to determine its proper operation and perform its function properly. Check the alignment of moving parts, breakage of parts, mounting and any other condition that may affect its operation. Any part that is damaged should be repaired or replaced immediately. Do not use the tool if the switch does not turn on or off.

- Never leave a running tool unattended. Turn off the ignition key.

- The engine of this machine can emit sparks, and explode flammable gases.

- Extension cables. Make sure your extension cord is in good condition. When using an extension, be sure of their ability to transmit the electrical current used by your product. An undersized cord will cause drop in voltage resulting in loss of power and overheating. The following table shows the correct size to be used depending on the cable diameter and amperage rate. If in doubt, use a cable with a higher level of capacity. **IMPORTANT:** Do not use an extension cord with length above 20 meters.

Cable 2 wires		Cable 3 wires	
Ø (mm ²)	Amperage	Ø (mm ²)	Amperage
0,5	9	0,5	8
1,0	13	1,0	12
1,5	16,5	1,5	15
2,5	23	2,5	20

Additional safety rules for wood jointer:

CAUTION: FAILURE TO ATTEND THESE WARNINGS MAY RESULT IN PERSONAL INJURY AND SERIOUS DAMAGE TO THE MACHINE.



ALWAYS USE PROPER PROTECTIVE EQUIPMENTS TO OPERATE THIS MACHINE.

- Always use safety glasses. Also use face or dust mask if cutting operation is dusty. Everyday eyeglasses only have impact resistant lenses, they are NOT safety glasses.

- Keep guards in place and working order.

- Protect the electric power supply line with at least a 20 amp fuse or a circuit breaker switch.

- Make sure that the advance is turning in the right direction.

- Make sure that the knobs and screws are properly tightened and safe before starting any operation.

- Keep sharp tools.

- Keep vents free of chips or dirt engines.

- Keep hands away from moving or sharp parts.

- Turn off the machine and unplug the power cord before maintenance or adjustments of the tool.

- Support long pieces with a clamping device for wood.

- Do not attempt to operate the machine in another voltage beyond designated.
- Do not use larger or smaller tools than recommended.
- Do not apply lubricant to the tools during use.
- Do not operate without some parts of the machine.
- Do not put your hands less than 4in from the shaft.
- Do not put your hands in closed parts of the machine unless it is turned off and unplugged.
- Do not use lubricants or cleaners (particularly sprays and aerosols) in the vicinity of the plastic guard. The polycarbonate material used in the guard is sensitive to certain chemicals.

WARNING: Some dust created by the act of sanding, cutting, grinding, drilling and other construction-related activities contains chemicals that can cause cancer, birth defects or other reproductive harm. Some examples of these products are: Lead-based paint; crystal silica bricks, concrete and other masonry products; and arsenic and chromium from chemically treated wood.

CAUTION: Do not connect the unit to the power outlet until all instructions have been read and understood. Always tighten the adjustment tabs before using the machine. Think: "I can prevent accidents".

Do not operate the machine unless the guards are in their proper places. Always use protective goggles.

Electrical connection

The wood jointer has engine 1-phase 110V. To avoid burning risk, check the voltage of your outlet before starting the machine. If necessary make the change of your power with the help of a specialist. Ensure that your power supply is in accordance with the designated on the board. A 10% decrease in voltage or more will cause loss of power and overheating. All equipment MAKSIWA are tested at the factory. If this machine does not work, check the electricity supply. Check the compatibility of your outlet and plug the machine. Do not do patches and adaptations. To avoid electrical shock and damage to the equipment always ground the machine.

Familiarization

Put the machine on a smooth and flat surface. Check the pictures and watch the descriptions to familiarize yourself with its components. The next section will deal with the necessary adjustments for the proper functioning of the machine. You should know these

parts and will need to know where they are.

Especifications

Table Lenght: 47-2/8"
 Table Widht: 6"
 Max. depth capacity: 1/8"
 Speed: 5,200 RPM
 Number of knives: 3
 Knife dimensions:
 158 x 18 x 3 mm (6-13/64" x 45/64" x 3/32")
 Fence tilt: 45° to 90°
 Motor: 1 HP - 1 - 3 Phases
 Volts/Amps:
 1 Phase: 127 V - 16 A or 220 V - 8 A
 3 Phases: 220 V - 3,5 A or 380 V - 2,1 A
 Weight: 267 Lbs

Transport and Installation

By ergonomic issues, this equipment must be carried by at least two people, holding by the handles located on the sides of the box.

For packaging purposes, the machine is not fully assembled. If you notice any damage caused by transportation, while you open the package, notify your supplier immediately. Do not operate the machine.

Dispose the packaging in a friendly way with the environment.

The wood jointer is designed to operate indoors and should be placed on a firm, stable and level surface.

To mount the jointer to the stand:

1. Remove the outer cover of the cabinet.
2. With the help of an assistant, lift the jointer onto the cabinet.
3. Align the three bolt holes on the jointer with the three holes on the cabinet.

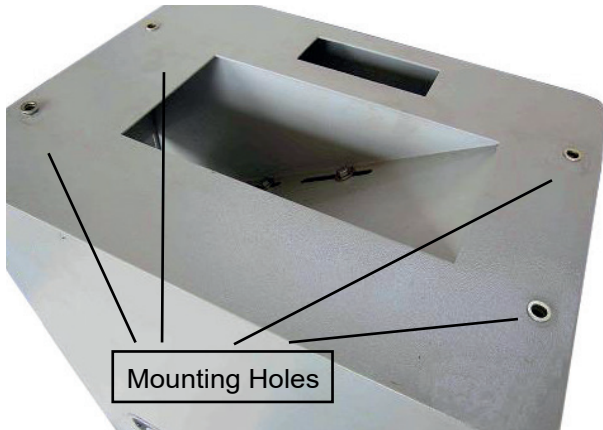

4. Using the 8 mm hex wrench, secure the jointer to the cabinet with the M10-1,5 x 20 cap screws, flat washers, and lock washers.

NOTE: Reach through the dust vent for access to the forward mounting hole as shown in next figure.



To Install the V-Belt

1. Using a 13 mm wrench, loosen, but DO NOT remove the motor mount bolts



2. Lift the motor upward far enough to allow the V-Belts to be placed around the cutterhead pulley and motor pulley.

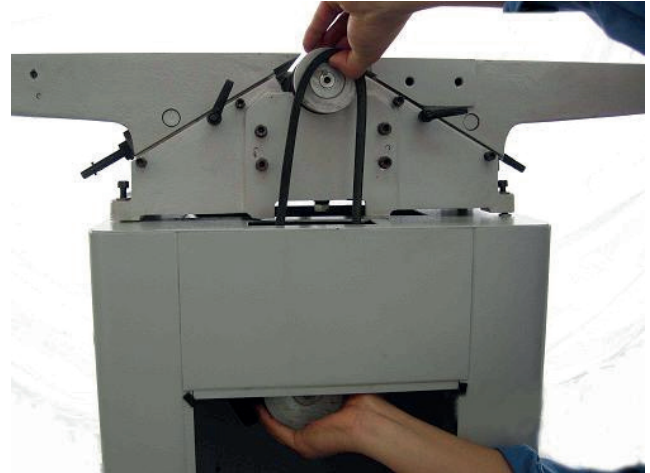

3. Carefully allow the motor to slide downward tensioning the V-Belts with the weight of the motor.

4. Looking from the top, sight down the V-Belts and pulleys and check to see that the pulleys are parallel and aligned with each other.

- If the pulleys are aligned, tighten the motor mounts loosened in Step 1 and go to Step 7.

- If the pulleys are not aligned, perform Step 5 e 6.

5. Remove the V-Belt, loosen the set screws on the end of the motor pulley, and align the motor pulley with the cutterhead pulley. If needed, the motor can be loosened and moved in or out to bring the motor pulley into alignment with the cutterhead pulley.

6. Tighten the set screws, replace the V-Belts and repeat Step 4. Belts should be perfectly parallel and aligned as shown in next figure.

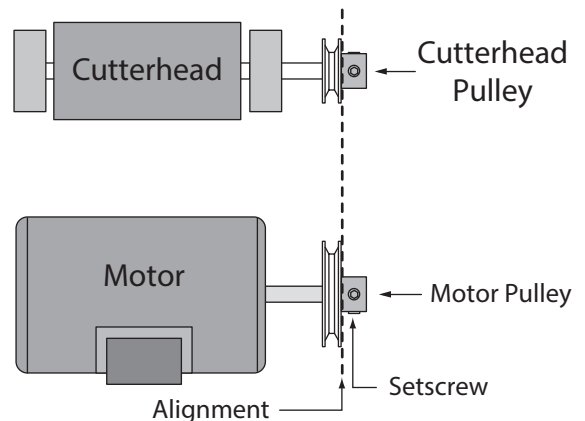

7. Replace the access cover on the cabinet.

To install the carriage mounting bracket:

1. Align the locating pins on the back of the carriage mounting bracket with the sockets on the jointer table.

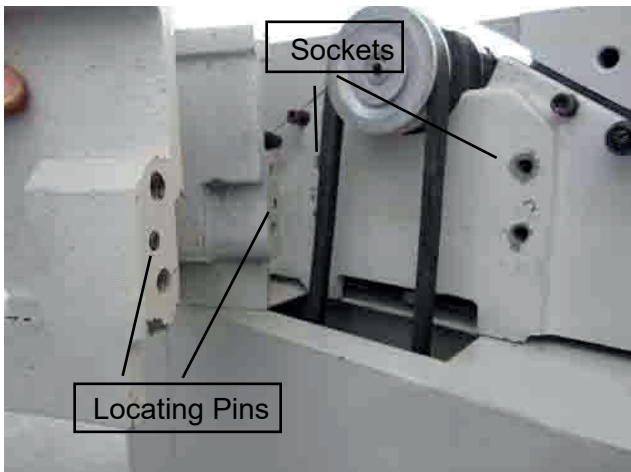

2. Tighten the carriage mounting bracket to the jointer table with the cap screws, lock washers and flat washers.

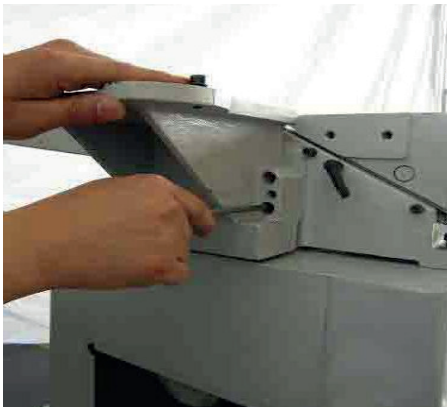

To install the fence carriage assembly:

1. Use two M8-1,25 x 20 cap screws, lock washers and flat washers to secure the fence carriage assembly to the carriage mounting bracket.

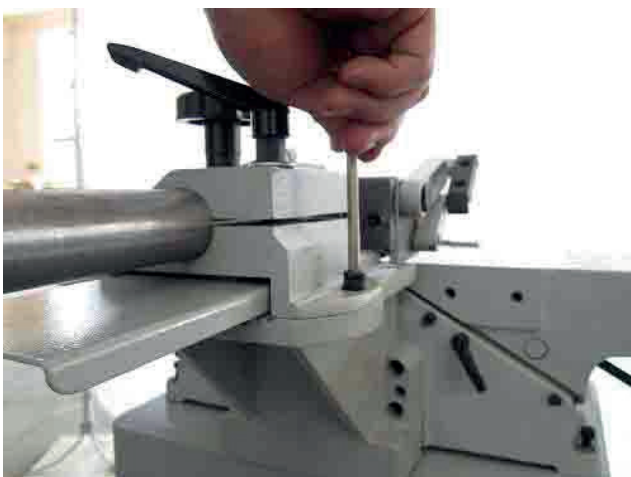

2. Use two M8-1,25 x 20 cap screws, lock washers and flat washers to secure the fence assembly to the fence carriage assembly.



3. Thread the fence tilting handles into the fence.

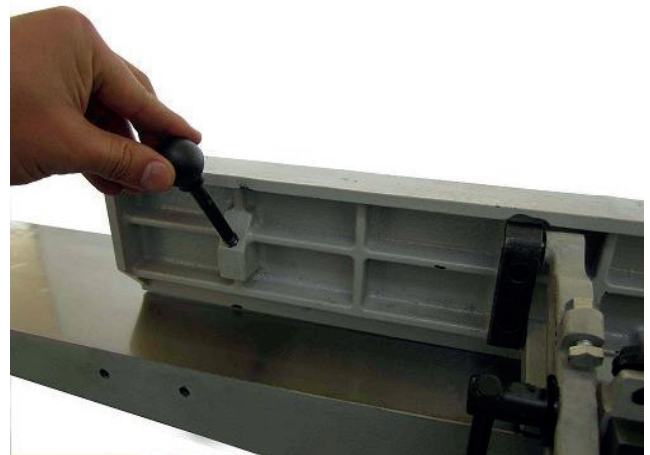

To install the cutterhead guard:

1. Wind the torsion spring knob back counterclockwise a half turn and slide the guard shaft into the casting shown in next figure. Make sure the slot on the cutterhead guard shaft fits over the pin that sits inside the spring knob barrel.



2. Test the guard by pulling it back and letting go.

To install the dust port:

NOTE: if you choose to not use a dust collection system, don't install the dust port. Chips will build up inside the cabinet and clog.

1. Place the dust port over the dust vent in the side of the cabinet.
2. Use the four M5*10 Phillips head screws and flat washers to secure the dust port to the cabinet.



3. Attach to dust collection system.

To install the power switch e support arm:

1. Install the support arm with the M8*16 cap screws and flat washers as shown in next figure:



To install the handwheel:

1. Remove the screw and flat washer already mounted to the handwheel shaft.
2. Secure the handwheel to the shaft with the hardware removed in Step 1.



Setting Outfeed Table Height:

The outfeed table must be level with the knives when they are at top-dead-center. This adjustment has been made at the factory but should be checked again before operating your jointer. This adjustment will also have to be made any time you perform maintenance on the cutterhead or knives.

To set the outfeed table height:

1. Place a straightedge on the outfeed table so it extends over the cutterhead.
2. Rotate the cutterhead pulley until one of the knives is at top-dead-center (TDC), illustrated in next figure:

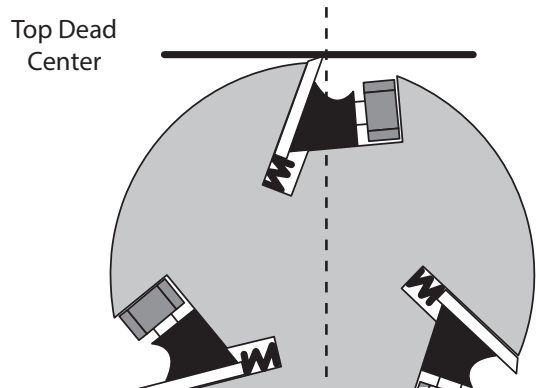

3. Raise or lower the outfeed table until the knife just touches the straightedge.

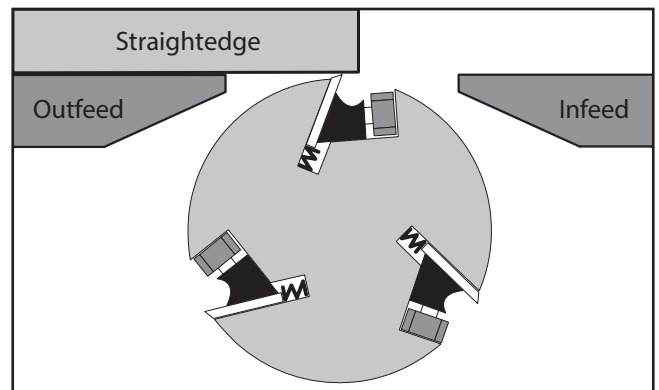

4. Lock the outfeed table in next figure (outfeed table lock):

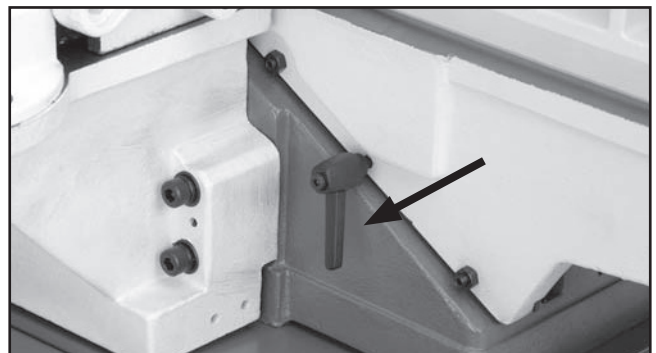

Starting the machine:

1. Read the entire instruction manual.
2. make sure the cutterhead guard is installed and correctly adjusted.
3. Make sure all tools and foreign objects have been removed from the machine.
4. Connect your machine to the power source.
5. Press the START button to turn the machine ON
 - The jointer should run smoothly with little or no vibration;
 - Immediately stop the jointer if you suspect any problems and to troubleshoot/fix any problems before starting the jointer again.

Recommended Adjustments

For your convenience the adjustments listed below have been performed at the factory and no further setup is required to operate your machine.

However because of the many variables involved with shipping, we recommend that you at least verify the following adjustments to ensure the best possible results from your new machine.

Step-by-step instructions for these adjustments can be found in SECTION 4.

Factory adjustments that should be verified:

1. Knife Settings.
2. Depth Scale Calibration.
3. Fence Stop Accuracy.

Schedule Maintenance

For optimum performance from your machine. follow this maintenance schedule and refer to any specific instructions given in this section.

Daily

- Vacuum all dust on and around the machine.
- Wipe down tables and all other unpainted cast iron with a metal protectant.

Monthly Check

- V-Belt tension, damage or wear;

- Clean/vacuum dust buildup from inside cabinet and off motor.

V-Belt

To ensure optimum power transmission from the motor to the blade, the V-Belt must be in good condition (free from cracks, fraying and wear) and properly aligned and tensioned.

Cleaning

Cleaning the DE.1200/3 is relatively easy. Vacuum excess wood chips and sawdust, and wipe off the remaining dust with a dry cloth. If any resin has built up, use a resin dissolving cleaner to remove it. Treat all unpainted cast iron and steel with a non-staining lubricant after cleaning.

Unpainted Cast Iron

Protect the unpainted cast iron surfaces on the table by wiping the table clean after every use this ensures moisture from wood dust does not remain on bare metal surfaces. Keep tables rustfree with regular applications.

Lubrication

Since all bearings are sealed and permanently lubricated, simply leave them alone until they need to be replaced. DO NOT lubricate them.

Table ways and the fence assembly should not be lubricated. If the tables appear to be stuck, disassemble and clean any foreign materials from the ways. Re-assemble and reset the gibs.

SERVICE

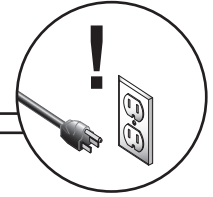

Motor & Machine Operation

Symptom	Possible Cause	Possible Solution
Motor will not start.	<ol style="list-style-type: none"> 1. Emergency stop button depressed. 2. Low voltage. 3. Open circuit in motor or loose connections. 	<ol style="list-style-type: none"> 1. Lift the cover on the emergency stop button to allow it to pop out. 2. Check power line for proper voltage. 3. Inspect all lead connections on motor for loose or open connections.
Fuses or circuit breakers blow.	<ol style="list-style-type: none"> 1. Short circuit in line cord or plug. 	<ol style="list-style-type: none"> 1. Repair or replace cord or plug for damaged insulation and shorted wires.
Motor fails to develop full power (output of motor decreases rapidly with decrease in voltage at motor terminals).	<ol style="list-style-type: none"> 1. Power supply circuit overloaded with lights, appliances, and other motors. 2. Undersized wires or circuits too long. 	<ol style="list-style-type: none"> 1. Reduce load on circuit. 2. Increase wire sizes or reduce length of the circuit.
Motor overheats.	<ol style="list-style-type: none"> 1. Motor overloaded during operation. 2. Air circulation through the motor restricted. 	<ol style="list-style-type: none"> 1. Reduce load on motor; take lighter cuts. 2. Clean out motor to provide normal air circulation.
Motor stalls or shuts off during a cut.	<ol style="list-style-type: none"> 1. Motor overloaded during operation. 2. Short circuit in motor or loose connections. 3. Circuit breaker tripped. 	<ol style="list-style-type: none"> 1. Reduce load on motor; take lighter cuts. 2. Repair or replace connections on motor for loose or shorted terminals or worn insulation. 3. Install correct circuit breaker; reduce # of machines running on that circuit (circuit overload).
Blade slows when cutting or makes a squealing noise, especially on start-up.	<ol style="list-style-type: none"> 1. V-belt loose. 2. V-belt worn out. 	<ol style="list-style-type: none"> 1. Tighten V-belt 2. Replace V-belt
Loud repetitious noise coming from machine.	<ol style="list-style-type: none"> 1. Pulley setscrews or keys are missing or loose. 2. Motor fan is hitting the cover. 3. V-belts are damaged. 	<ol style="list-style-type: none"> 1. Inspect keys and setscrews. Replace or tighten if necessary. 2. Adjust fan cover mounting position, tighten fan, or shim fan cover. 3. Replace V-belts
Vibration when running or cutting.	<ol style="list-style-type: none"> 1. Loose or damaged blade. 2. Damaged V-belt. 3. Worn cutterhead bearings. 	<ol style="list-style-type: none"> 1. Tighten or replace blade. 2. Replace. 3. Check/replace cutterhead bearings.

Table

Symptom	Possible Cause	Possible Solution
Tables are hard to adjust.	<ol style="list-style-type: none"> 1. Table lock is engaged or partially engaged. 2. Table gibs are too tight. 	<ol style="list-style-type: none"> 1. Completely loosen the table lock. 2. Re-adjust the table gibs
Excessive play in table movement.	<ol style="list-style-type: none"> 1. Table gibs are too loose. 	<ol style="list-style-type: none"> 1. Re-adjust the table gibs

Cutting

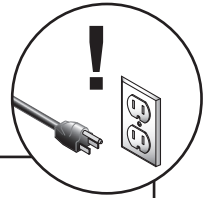

Symptom	Possible Cause	Possible Solution
Excessive snipe (gouge in the end of the board that is uneven with the rest of the cut).	<ol style="list-style-type: none"> 1. Outfeed table is set too low. 2. Operator pushing down on end of workpiece. 	<ol style="list-style-type: none"> 1. Align outfeed table with cutterhead knife at top dead center. 2. Reduce/eliminate downward pressure on that end of workpiece.
Workpiece stops in the middle of the cut.	<ol style="list-style-type: none"> 1. Outfeed table is set too high. 	<ol style="list-style-type: none"> 1. Align outfeed table with cutterhead knife at top dead center
Chipping.	<ol style="list-style-type: none"> 1. Knots or conflicting grain direction in wood. 2. Nicked or chipped blades. 3. Feeding workpiece too fast. 4. Taking too deep of a cut. 	<ol style="list-style-type: none"> 1. Inspect workpiece for knots and grain ; only use clean stock. 2. Adjust one of the nicked knives side-ways; or replace knives 3. Slow down the feed rate. 4. Take a smaller depth of cut. (Always reduce cutting depth when surface planing or working with hard woods.)
Fuzzy Grain.	<ol style="list-style-type: none"> 1. Wood may have high moisture content or surface wetness. 2. Dull knives. 	<ol style="list-style-type: none"> 1. Check moisture content and allow to dry if moisture is too high. 2. Replace knives
Long lines or ridges that run along the length of the board.	<ol style="list-style-type: none"> 1. Nicked or chipped knives. 	<ol style="list-style-type: none"> 1. Adjust one of the nicked knives side-ways; or replace knives
Uneven cutter marks, wavy surface, or chatter marks across the face of the board.	<ol style="list-style-type: none"> 1. Feeding workpiece too fast. 2. Knives not adjusted at even heights in the cutterhead. 	<ol style="list-style-type: none"> 1. Slow down the feed rate. 2. Adjust the knives so they are set up evenly in the cutterhead
Board edge is concave or convex after jointing.	<ol style="list-style-type: none"> 1. Board not held with even pressure on infeed and outfeed table during cut. 2. Board started too uneven. 3. Board has excessive bow or twist along its length. 4. Insufficient number of passes. 	<ol style="list-style-type: none"> 1. Hold board with even pressure as it moves over the cutterhead. 2. Take partial cuts to remove the extreme high spots before doing a full pass. 3. Surface plane one face so there is a good surface to position against the fence. 4. It may take 3 to 5 passes to achieve a perfect edge, depending on the starting condition of the board and the depth of cut.
Uneven cut or breakout when rabbeting.	<ol style="list-style-type: none"> 1. Uneven feed rate. 2. Depth of cut too deep. 3. Knives not adjusted evenly with each other in the cutterhead. 4. Nicked or chipped knives. 	<ol style="list-style-type: none"> 1. Feed the board evenly and smoothly during the cut. 2. Raise the infeed table to take a smaller depth of cut. Never exceed $\frac{1}{16}$" per pass when rabbeting. 3. Adjust the knives so they are set up evenly in the cutterhead 4. Adjust one of the nicked knives side-ways; replace knives

Inspecting Knives

The height of the knives can be easily and quickly inspected with the knife setting jig. This inspection will ensure that the knives are set in the cutterhead as they should be. Usually this is done before calibrating the outside table or when troubleshooting.

To inspect the knives:

1. Disconnect the jointer from the power source!
2. Remove the cutterhead guard or block it out of the way.
3. Lower the infeed table to the 1/2" scale mark.
4. Place the knife jig on the cutterhead, directly over a knife, as shown in next figure.

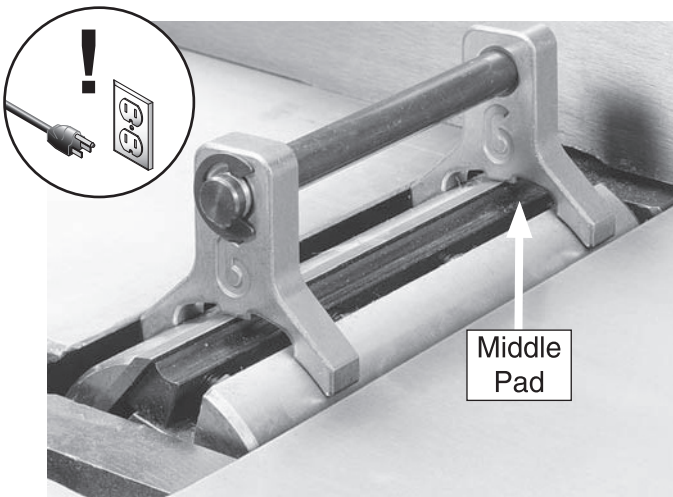

5. Carefully inspect how the jig touches the cutterhead and the knife.

- If both outside legs of the jig sit firmly on the cutterhead and the middle pad just touches the knife, then that knife is set correctly. (Repeat this inspection with the other knives).

- If the jig does not sit firmly on the cutterhead and touch the knife edge as described, then reset that knife. (Repeat this inspection with the other knives).

Setting Knives

Setting the knives correctly is crucial to the proper operation of the jointer and is very important in keeping the knives sharp. If one knife is higher than the others, it will do the majority of the work, and thus, dull much faster than the others.

The knife jig included with the jointer is designed to set the knives at the correct height.

To set the knives

1. Disconnect the jointer from the power source!
2. Remove the cutterhead guard from the table and lower the infeed and outfeed tables as far as they go. This will give you unrestricted access to the cutterhead.
3. Remove the cabinet cover to expose the V-Belt.
4. Use the V-Belt to rotate the cutterhead to access the cutterhead knives.
5. Loosen the cutterhead gib bolts, starting in the middle, and alternating back and forth until all of the gib bolts are loose, but not falling out.

NOTE: If this is the first time you are setting the knives, remove the gib and knife from the cutterhead. Decide which adjustment option you are going to use between the jack screws and the springs. If you decide to use the jack screws, remove the springs from the cutterhead. If you decide to use the springs, you can just thread the jack screws completely into the cutterhead so they will not get lost. Replace the gib and knife.

6. Position the knife gouge over the knife as shown in next figure and loosen the gib bolts until the knife is completely loose.

7. Jack Screws - Using a 3 mm hex wrench, find the jack screws through the access holes in the cutterhead and rotate the jack screws to raise or lower the knife. When the knife is set correctly, it will barely touch the middle pad of the knife setting jig. Snug the gib bolts tight enough to just hold the knife in place. Repeat Steps 5-7 with the rest of the knives.

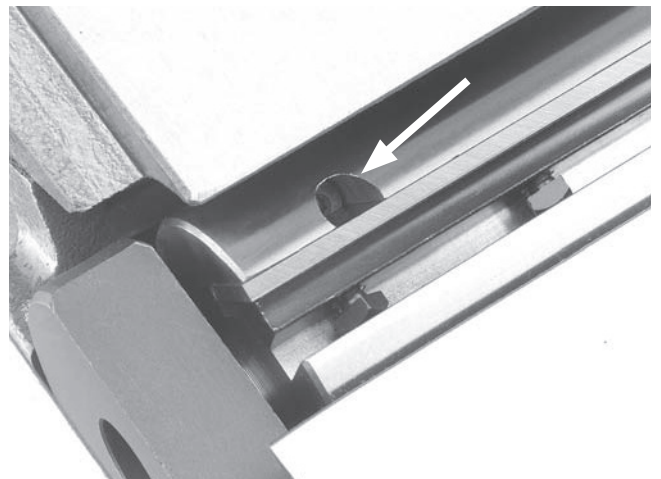

8. Rotate the cutterhead to the first knife you started with. Slightly tighten all the gib bolts, starting at the ends and working your way to the middle by alternating left and right. Repeat this step on the rest of the knives.

9. Final tighten each gib bolt.

10. Adjust the outfeed table to match the new knife heights.

Calibrating Depth Scale

The depth scale on the infeed table can be calibrated or “zeroed” if it is not correct.

To calibrate the depth scale

1. Set the outfeed table height as described in the Setting Outfeed Table Height su-section.
2. Place a straightedge across the infeed and outfeed tables.
3. Adjust the infeed table until it is level with the outfeed table.

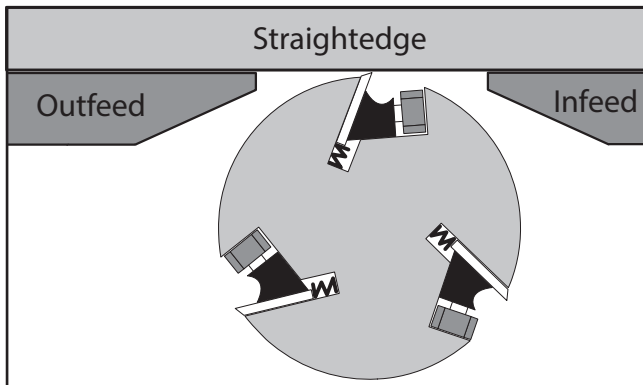

Infeed table adjusted even with outfeed table and knife at TDC.

4. Using a screwdriver, adjust the scale pointer exactly to “0”.

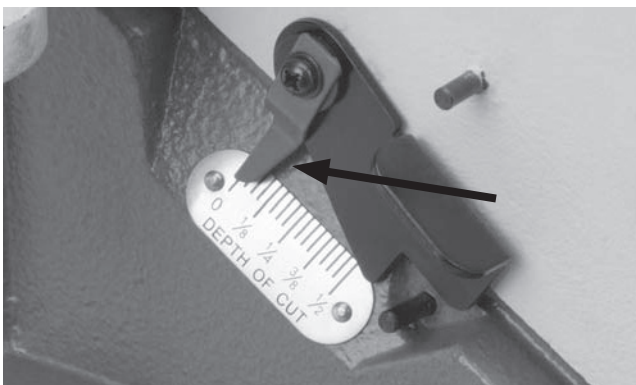

Depth-of-cut pointer adjusted to “0” position.

Setting Fence Stops

The fence stops are adjustable nuts and bolts that simplify the task of adjusting the fence to 45° inward, 90°, and 45° outward (135°).

To set the 45° inward fence stop:

1. Using a 45° square, adjust the fence to the 45° inward position:

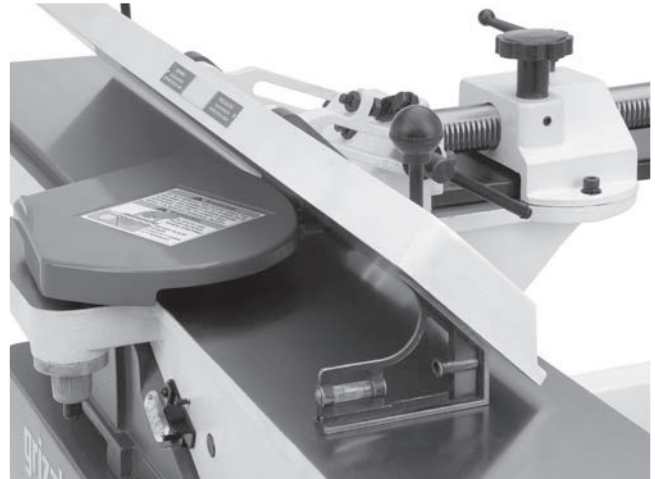

Adjusting fence 45° inward.

2. Loosen the jam nut shown:

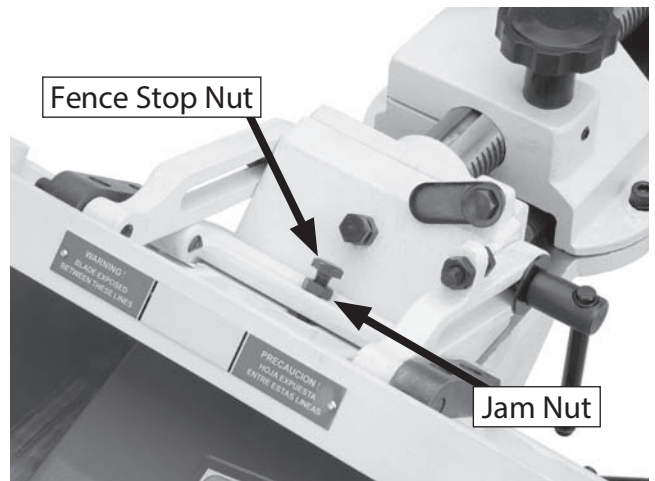

45° inward fence stop jam nut

3. Adjust the 45° inward fence stop nut until it makes contact with the back of the fence bracket.

4. Retighten the jam nut loosened in Step 2 and recheck.

To set the 90° fence stop:

1. Flip the 90° swing stop the position shown next:

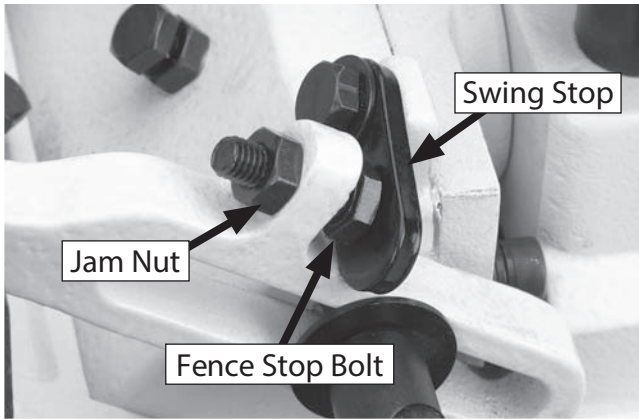

90° swing stop engaged.

2. Using a 90° square, adjust the fence to the 90° position using the fence stop bolt and jam nut:

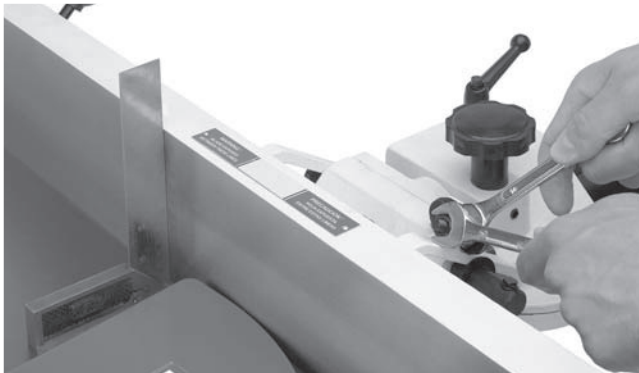

90° swing stop engaged.

3. Loosen the jam nut on the 90° fence stop bolt.

4. Adjust the 90° fence stop bolt until it makes contact with the 90° swing stop.

5. Retighten the jam nut loosened in Step 3 and recheck.

To set the 45° outward fence stop:

1. Flip the 90° swing stop out of the way as shown in next figure.

2. Using a sliding bevel adjusted to 135°, adjust the fence to the 135° (45° outward) position.

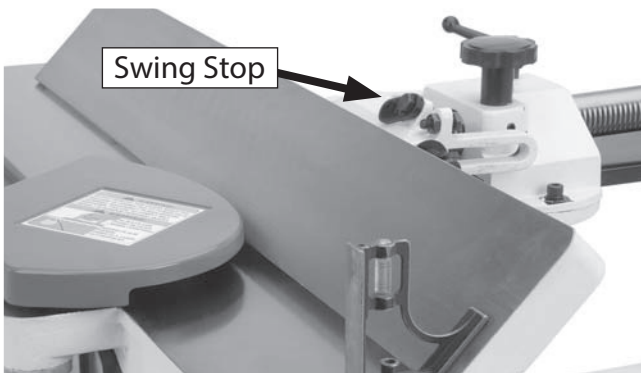

Adjusting fence 45° outward.

3. Loosen the jam nut on the 45° outward fence stop bolt.

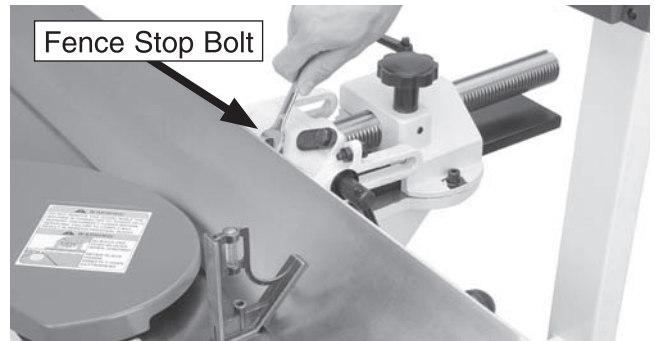

45° outward fence stop jam nut

4. Adjust the 45° outward fence stop bolt until it makes contact with the back of the fence.

5. Retighten the jam nut loosened in Step 3 and recheck.

Adjusting Gibs

The function of the table gibs is to eliminate excessive play in the table movement. The gibs also control how easy it will be to move the tables up and down.

To adjust the table gibs:

1. Using a 100mm wrench, loosen the two outfeed table gib nuts on the side of the jointer base.

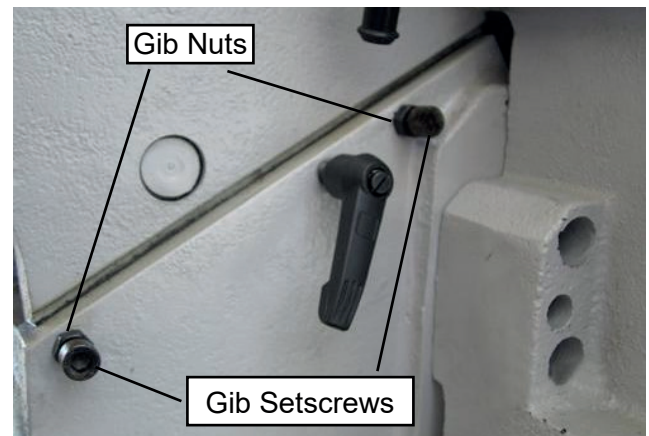

2. Using a 3mm hex wrench, evenly tighten the gib stescrews a small amount, then check the table by moving it up and down. Adjust the setscrews as needed until the friction of the table movement is balanced between minimal play and ease of movement.

NOTE: Tighter gibs reduce play but make it harder to adjust the tables.

3. Repeat Steps 1-2 with the other table.

4. Set the outfeed table height as described in stting Outfeed Table Height.

TECHNICAL ASSISTENCE

WARRANTY TERM

The MAKSIWA assures the owner of his equipment, identified by the date of issue of the purchase invoice, a warranty of two (2) years, as follows:

1. The warranty period begins on the date of the commercial invoice.
2. Within the warranty period, the hand labor and the components replaced by manufacturing defect will be provided for free as long as duly proved by Maksiwa Service.
3. Third-party manufacturing equipment that makes up the MAKSIWA equipment (such as motors, electrical equipment, belts etc.) are subject to the terms and conditions of warranty of their respective manufacturers.
4. In case of exchange for the warranty, please return the defective part for the manufacturer urgently.
5. Costs and risks of transport will be by the machine owner.
6. Equipment installation expenses and workplace adaptations are due to the machine owner.
7. When you notice any defect or malfunction when receiving the equipment, get in touch immediately with the manufacturer or resale. Do not turn it on.
8. Not included in this warranty technical visits aimed at cleaning or adjustments caused by wear, resulting from normal use of the equipment.
9. The warranty does not cover problems caused by mistreatment, carelessness, misuse or inappropriate use of the functions designed for this equipment in this manual, as well as poorly executed operations by untrained operators to operate it.
10. The MAKSIWA is not responsible for lost productivity, direct or indirect damages caused to the owner of the equipment or to third parties, or any other expense, including lost profits.
11. Even under warranty, you may lose its validity as follows:
 - a) Application of non-original components;
 - b) Alteration of its original features;
 - c) Lack of proper maintenance;
 - d) Improper use of the equipment;
 - e) Change in equipment or electronic connections;

f) Damage caused by mechanical shock or exposure to unsuitable conditions (humidity, salt spray, corrosive agents, etc.);

g) Damage caused by bad weather (floods, flooding, lightning, power outages etc.).

For your safety, trust the repairs, maintenance and adjustments (including inspection and replacement) for technical assistance recommended by MAKSIWA, always use genuine spare parts and accessories, reassembling to its original Edgebander the same way.

Manufactured by:
Maksiwa Industria e Comercio de Maquinas LTDA.
St Nelson Argenta, 436
Colombo - Parana - Brazil
Zipcode: 83402-220
CNPJ: 76.670.215/0001-81
www.maksiwa.com